

Wichita, KS – MAYB

July 11-12, 2015

**6<sup>th</sup> Grade Boys**

| <b>Pool A</b>      | <b>W</b> | <b>L</b> | <b>Pool B</b>      | <b>W</b> | <b>L</b> |
|--------------------|----------|----------|--------------------|----------|----------|
| 1. Wichita Falcons | I        | I        | 4. Arsenal         |          | II       |
| 2. NLHA Black      | II       |          | 5. Kansas MTXE 12U | I        | I        |
| 3. Wichita Jets    |          | II       | 6. NLHA Orange     | II       |          |

All teams to seed game and then on to bracket game  
Tie Breaker – 2 way tie = Head to Head, 3 way tie = coin flip

| <b>Saturday</b> | Court 1 | Court 2 |
|-----------------|---------|---------|
| 10:00           | -       | -       |
| 11:00           | 1-2     | 4-5     |
| 12:00           | -       | -       |
| 1:00            | 1-3     | 4-6     |
| 2:00            | -       | -       |
| 3:00            | 2-3     | 5-6     |
| 4:00            | -       | -       |
| 5:00            | G1      | G2      |
| 6:00            | -       | -       |
| 7:00            | G3      | -       |
|                 |         |         |
| <b>Sunday</b>   | Court 1 | Court 2 |
| 9:00            | G4      | -       |
| 10:00           | G5      | -       |
| 11:00           | G6      | -       |
| 12:00           | G7      | -       |
| 1:00            | G8      | -       |
| 2:00            | G9      | -       |
| 3:00            | G10     | -       |

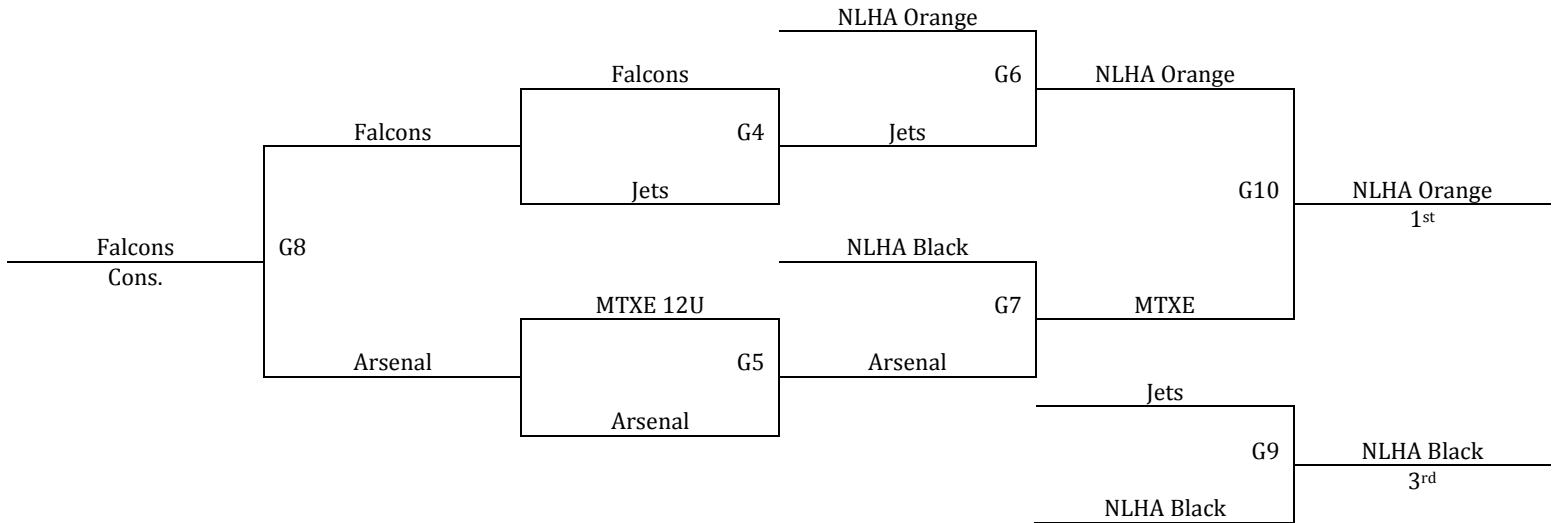
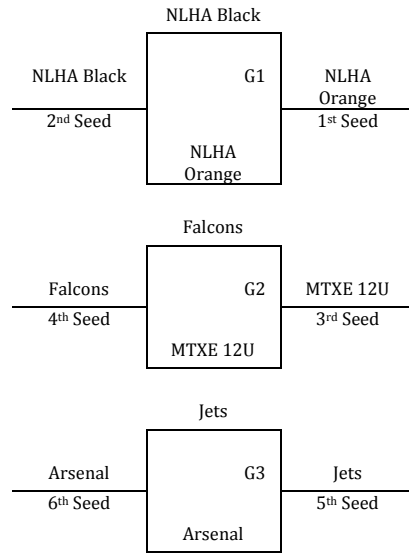

All Games at the Farha Sports Center: 3405 S Meridian Ave., Wichita, KS 67217

Wichita, KS – MAYB

July 11-12, 2015

**7<sup>th</sup> Grade Boys**

| <b>Pool A</b>                 | <b>W</b> | <b>L</b> |
|-------------------------------|----------|----------|
| 1. Crusaders                  |          | IIII     |
| 2. Eagles Gehlen              | II       | II       |
| 3. Kansas MTXE 13U            | III      | I        |
| 4. NLHA 7 <sup>th</sup> White | I        | III      |
| 5. Wichita Defenders          | IIII     |          |

All teams to Bracket

Tie Breaker – 2 way tie = Head to Head, 3 way tie = coin flip

| <b>Saturday</b> | <b>Court 1</b> | <b>Court 2</b> | <b>Court 5</b> | <b>Court 6</b> |
|-----------------|----------------|----------------|----------------|----------------|
| 10:00           | 1-2            | 3-4            | -              | -              |
| 11:00           | -              | -              | -              | -              |
| 12:00           | 1-3            | 2-5            | -              | -              |
| 1:00            | -              | -              | -              | -              |
| 2:00            | 1-4            | 3-5            | -              | -              |
| 3:00            | -              | -              | -              | -              |
| 4:00            | 1-5            | 2-4            | -              | -              |
| 5:00            | -              | -              | -              | -              |
| 6:00            | 2-3            | 4-5            | -              | -              |
| 7:00            | -              | -              | -              | -              |
| <b>Sunday</b>   | <b>Court 1</b> | <b>Court 2</b> | <b>Court 5</b> | <b>Court 6</b> |
| 9:00            | -              | -              | G1             | -              |
| 10:00           | -              | -              | -              | -              |
| 11:00           | -              | -              | -              | -              |
| 12:00           | -              | -              | G2             | G3             |
| 1:00            | -              | -              | -              | -              |
| 2:00            | -              | -              | -              | -              |
| 3:00            | -              | -              | G4             | G5             |

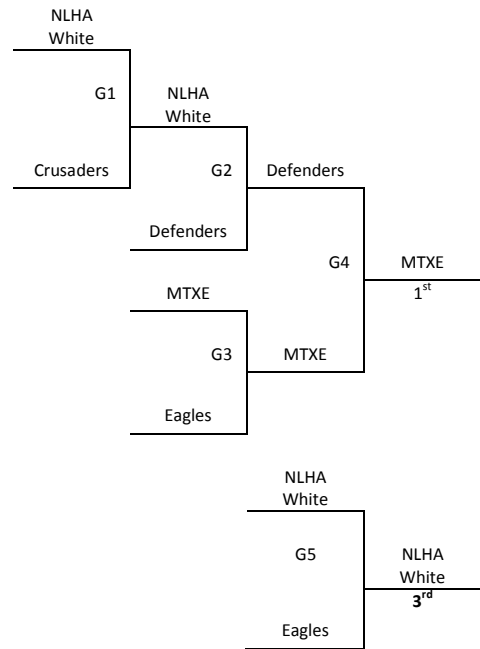

All Games at the Farha Sports Center: 3405 S Meridian Ave., Wichita, KS 67217

Wichita, KS – MAYB  
July 11-12, 2015

**8<sup>th</sup> Grade Boys**

| <b>Pool A</b>                 | <b>W</b> | <b>L</b> | <b>Pool B</b>                  | <b>W</b> | <b>L</b> |
|-------------------------------|----------|----------|--------------------------------|----------|----------|
| 1. Wichita Kats               | II       |          | 4. NLHA Orange 7 <sup>th</sup> | II       |          |
| 2. Ike Tigers                 |          | II       | 5. Jayhawks                    | I        | I        |
| 3. Colorado Cardinals Red 14U | I        | I        | 6. BirdDogs                    |          | II       |

All teams to seed game and then on to bracket game  
Tie Breaker – 2 way tie = Head to Head, 3 way tie = coin flip

| <b>Saturday</b> | Court 3 | Court 4 |
|-----------------|---------|---------|
| 10:00           | 1-2     | 4-5     |
| 11:00           | -       | -       |
| 12:00           | 1-3     | 4-6     |
| 1:00            | -       | -       |
| 2:00            | 2-3     | 5-6     |
| 3:00            | -       | -       |
| 4:00            | G1      | G2      |
| 5:00            | G3      | -       |
| 6:00            | -       | -       |
| 7:00            | -       | -       |
|                 |         |         |
| <b>Sunday</b>   | Court 3 | Court 4 |
| 9:00            | G4      | -       |
| 10:00           | G5      | -       |
| 11:00           | G6      | -       |
| 12:00           | G7      | -       |
| 1:00            | G8      | -       |
| 2:00            | G9      | -       |
| 3:00            | G10     | -       |

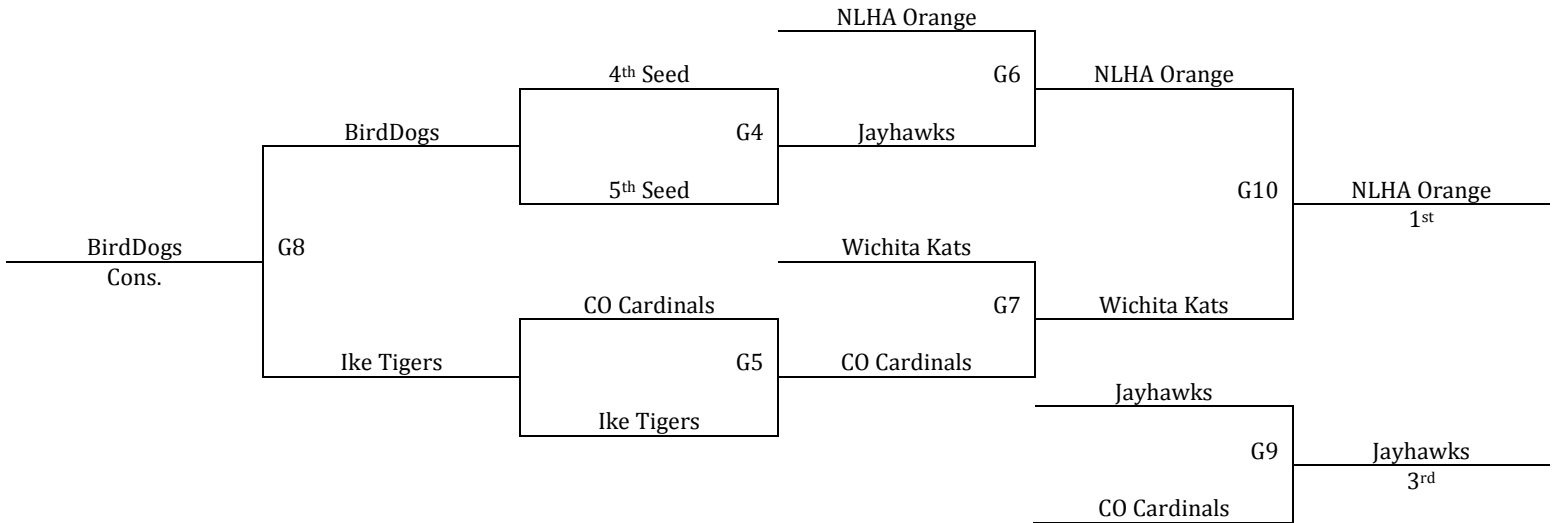
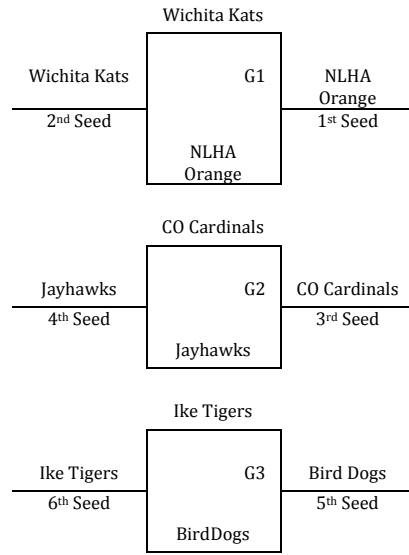

All Games at the Farha Sports Center: 3405 S Meridian Ave., Wichita, KS 67217

Wichita, KS – MAYB  
July 11-12, 2015

**HS Boys**

| <b>Pool A</b>             | <b>W</b> | <b>L</b> | <b>Pool B</b>           | <b>W</b> | <b>L</b> |
|---------------------------|----------|----------|-------------------------|----------|----------|
| 1. Wolf Creek Elite 11/12 |          | II       | 4. Wichita Padres 9/10  | II       |          |
| 2. Oz Elite 15U           | II       |          | 5. And 1 9/10           | I        | I        |
| 3. CK Flight 9/10         | I        | I        | 6. Wichita Bombers 9/10 |          | II       |

All teams to seed game and then on to bracket game  
Tie Breaker – 2 way tie = Head to Head, 3 way tie = coin flip

| <b>Saturday</b> | Court 2 | Court 3 | Court 4 |
|-----------------|---------|---------|---------|
| 10:00           | -       | -       | -       |
| 11:00           | -       | 1-2     | 4-5     |
| 12:00           | -       | -       | -       |
| 1:00            | -       | 1-3     | 4-6     |
| 2:00            | -       | -       | -       |
| 3:00            | -       | 2-3     | 5-6     |
| 4:00            | -       | -       | -       |
| 5:00            | -       | -       | G1      |
| 6:00            | -       | G2      | G3      |
| 7:00            | -       | -       | -       |
|                 |         |         |         |
| <b>Sunday</b>   | Court 2 | Court 3 | Court 4 |
| 9:00            | G4      | -       | -       |
| 10:00           | G5      | -       | -       |
| 11:00           | G6      | -       | -       |
| 12:00           | G7      | -       | -       |
| 1:00            | G8      | -       | -       |
| 2:00            | G9      | -       | -       |
| 3:00            | G10     | -       | -       |

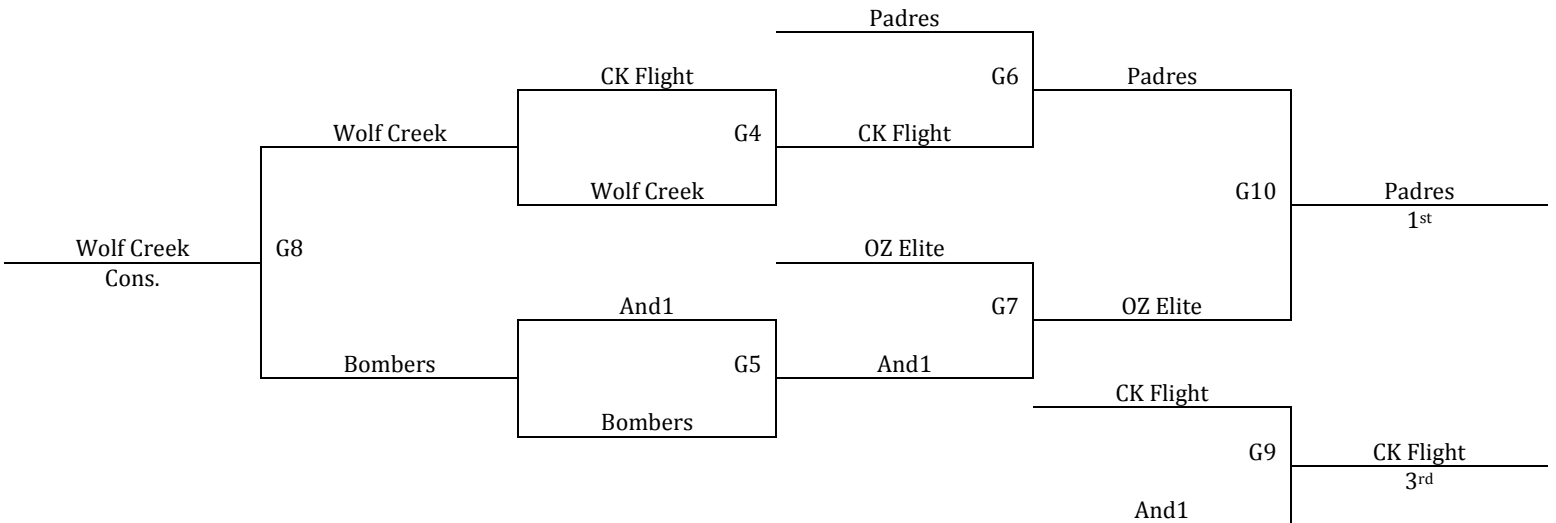
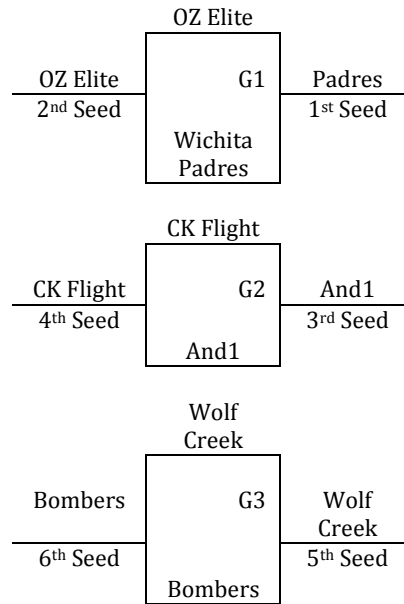

All Games at the Farha Sports Center: 3405 S Meridian Ave., Wichita, KS 67217

Wichita, KS – MAYB

July 11-12, 2015

**6<sup>th</sup> Grade Girls**

| <b>Pool A</b>          | <b>W</b> | <b>L</b> |
|------------------------|----------|----------|
| 1. Purple Thunder      |          | III      |
| 2. McPherson Lady Pups | I        | II       |
| 3. Raiders             | II       | I        |
| 4. Wichita Attack      | III      |          |

All teams to bracket play

Tie Breaker – 2 way tie = Head to Head, 3 way tie = coin flip

| <b>Saturday</b> | <b>Court 5</b> | <b>Court 6</b> |
|-----------------|----------------|----------------|
| 10:00           | -              | -              |
| 11:00           | -              | -              |
| 12:00           | 1-2            | 3-4            |
| 1:00            | -              | -              |
| 2:00            | -              | -              |
| 3:00            | 1-3            | 2-4            |
| 4:00            | -              | -              |
| 5:00            | -              | -              |
| 6:00            | 1-4            | 2-3            |
| 7:00            | -              | -              |
|                 |                |                |
| <b>Sunday</b>   | <b>Court 5</b> | <b>Court 6</b> |
| 9:00            | -              | -              |
| 10:00           | G1             | G2             |
| 11:00           | -              | -              |
| 12:00           | -              | -              |
| 1:00            | G3             | G4             |
| 2:00            | -              | -              |
| 3:00            | -              | -              |

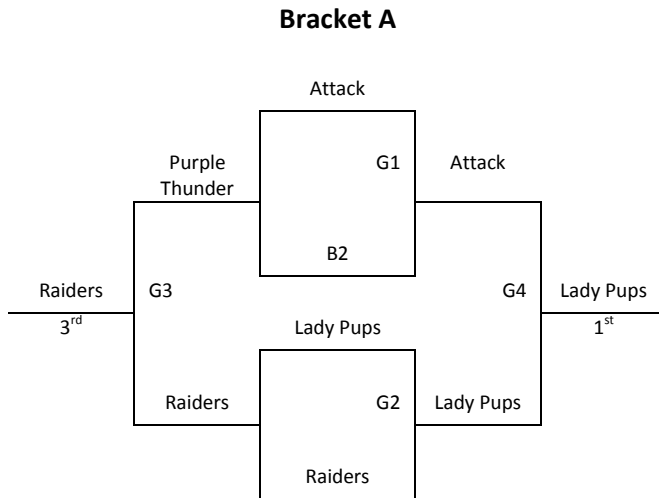

All Games at the Farha Sports Center: 3405 S Meridian Ave., Wichita, KS 67217



Wichita, KS – MAYB  
 July 11-12, 2015

**HS Girls**

| <b>Pool A</b>             | <b>W</b> | <b>L</b> |
|---------------------------|----------|----------|
| 1. SHS Tigers – 9/10      | II       | I        |
| 2. Golden Eagles – 9/10   |          | III      |
| 3. Plainville – 11/12     | I        | II       |
| 4. Lady Grizzlies – 11/12 | III      |          |

All teams to bracket play  
 Tie Breaker – 2 way tie = Head to Head, 3 way tie = coin flip

| <b>Saturday</b> | <b>Court 5</b> | <b>Court 6</b> |
|-----------------|----------------|----------------|
| 10:00           | -              | -              |
| 11:00           | 1-2            | 3-4            |
| 12:00           | -              | -              |
| 1:00            | -              | -              |
| 2:00            | 1-3            | 2-4            |
| 3:00            | -              | -              |
| 4:00            | -              | -              |
| 5:00            | 1-4            | 2-3            |
| 6:00            | -              | -              |
| 7:00            | -              | -              |
|                 |                |                |
| <b>Sunday</b>   | <b>Court 5</b> | <b>Court 6</b> |
| 9:00            | -              | -              |
| 10:00           | -              | -              |
| 11:00           | G1             | G2             |
| 12:00           | -              | -              |
| 1:00            | -              | -              |
| 2:00            | G3             | G4             |
| 3:00            | -              | -              |

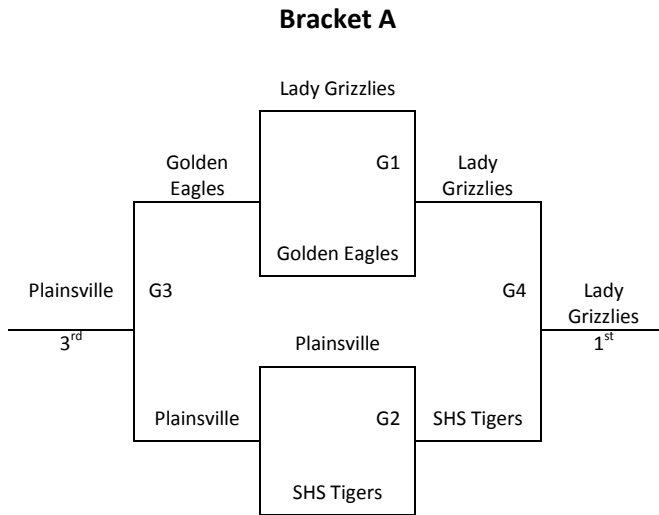

All Games at the Farha Sports Center: 3405 S Meridian Ave., Wichita, KS 67217