

Wichita, KS – MAYB
 May 16-17, 2015

4th/5th Grade Boys

Pool A	<u>W</u>	<u>L</u>
1. Oz Elite 10U Black	I	II
2. Cheney Sharp Shooters	III	
3. RC Select		III
4. NLHA -4 th	II	I

All teams to Bracket

Tie Breaker – 2 way tie = Head to Head, 3 way tie = coin flip

Saturday	Court 1	Court 2	Court 3	Court 4	Court 5	Court 6
10:00	-	-	1-2	3-4	-	-
11:00	-	-	-	-	-	-
12:00	-	-	1-3	2-4	-	-
1:00	-	-	-	-	-	-
2:00	-	-	-	-	-	-
3:00	-	-	-	-	-	-
4:00	-	-	-	-	-	-
5:00	-	-	-	-	1-4	2-3
6:00	-	-	-	-	-	-
Sunday	Court 1	Court 2	Court 3	Court 4	Court 5	Court 6
10:00	G1	G2	-	-	-	-
11:00	-	-	-	-	-	-
12:00	G3	G4	-	-	-	-
1:00	-	-	-	-	-	-
2:00	-	-	-	-	-	-
3:00	-	-	-	-	-	-

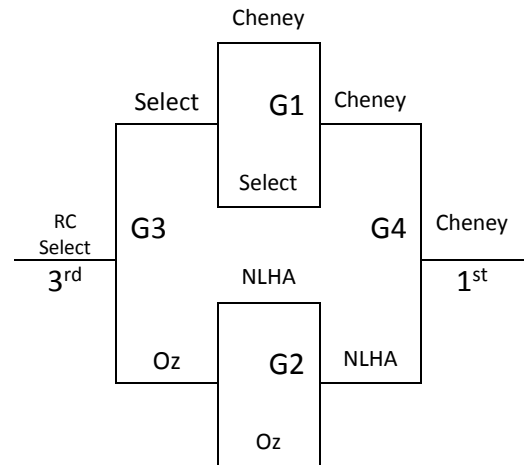

**All games played at the Fast Forward Facility
 5260 N Toler Drive Bel Aire, KS 67226**

Wichita, KS – MAYB
 May 16-17, 2015

6th Grade Boys

Pool A	<u>W</u>	<u>L</u>
1. CC Crusaders	I	II
2. Liberal 6 th	I	II
3. NLHA Black	I	II
4. River City Thunder	III	

All teams to Bracket

Tie Breaker – 2 way tie = Head to Head, 3 way tie = coin flip

Saturday	Court 1	Court 2	Court 3	Court 4
10:00	-	-	-	-
11:00	-	-	-	-
12:00	-	-	-	-
1:00	-	-	1-2	3-4
2:00	-	-	-	-
3:00	-	-	1-3	2-4
4:00	-	-	-	-
5:00	-	-	1-4	2-3
6:00	-	-	-	-
Sunday	Court 1	Court 2	Court 3	Court 4
10:00	-	-	-	-
11:00	-	-	-	-
12:00	-	-	-	-
1:00	G1	G2	-	-
2:00	-	-	-	-
3:00	G3	G4	-	-

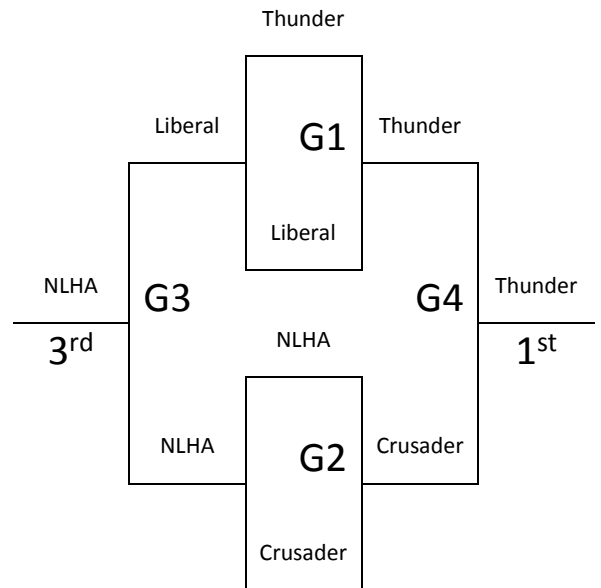

**All games played at the Fast Forward Facility
 5260 N Toler Drive Bel Aire, KS 67226**

Wichita, KS – MAYB
 May 16-17, 2015

7th Grade Boys

Pool A	<u>W</u>	<u>L</u>
1. Wichita Fury		III
2. Eagles Schoning	II	I
3. Wichita Defenders	I	II
4. NLHA Black	III	

All teams to Bracket

Tie Breaker – 2 way tie = Head to Head, 3 way tie = coin flip

Saturday	Court 1	Court 2
10:00	-	-
11:00	-	-
12:00	-	-
1:00	-	-
2:00	1-4	2-3
3:00	-	-
4:00	1-3	2-4
5:00	-	-
6:00	1-2	3-4
Sunday	Court 1	Court 2
10:00	-	-
11:00	G1	G2
12:00	-	-
1:00	-	-
2:00	G3	G4
3:00	-	-

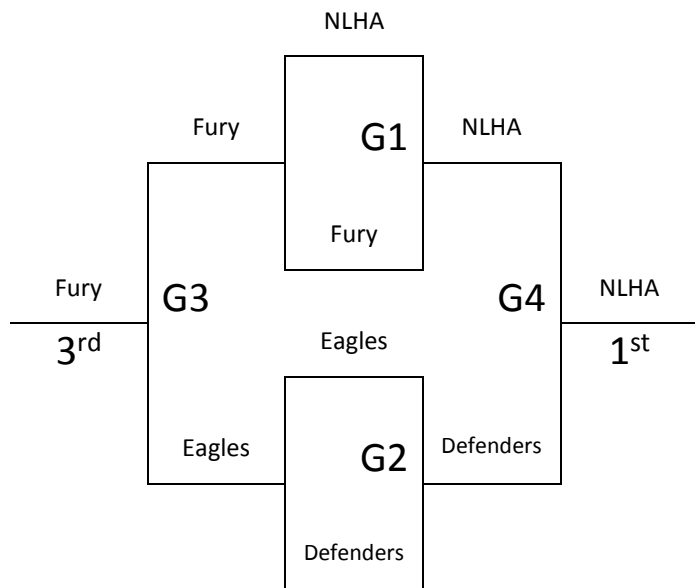

**All games played at the Fast Forward Facility
 5260 N Toler Drive Bel Aire, KS 67226**

Wichita, KS – MAYB
 May 16-17, 2015

7th/8th Grade Boys

Pool A	W	L	Pool B	W	L
1. Mavericks	I	II	5. Snipers	II	II
2. Sedgwick Cardinals	I	II	6. Mid KS Elite	IIII	
3. RC Select All-Stars	I	II	7. Power House	II	II
4. NLHA Orange	III		8. ALBL	I	III
			9. Eclipse SW	I	III

Top 2 teams in each pool to Bracket A, others to B
 Tie Breaker – 2 way tie = Head to Head, 3 way tie = coin flip

Saturday	Court 5	Court 6
10:00	5-6	7-8
11:00	1-2	3-4
12:00	5-7	6-9
1:00	1-3	2-4
2:00	5-8	7-9
3:00	1-4	2-3
4:00	5-9	6-8
5:00	-	-
6:00	6-7	8-9
Sunday	Court 5	Court 6
10:00	G5	-
11:00	G1	G2
12:00	G6	G7
1:00	G3	G4
2:00	G8	G9
3:00	-	-

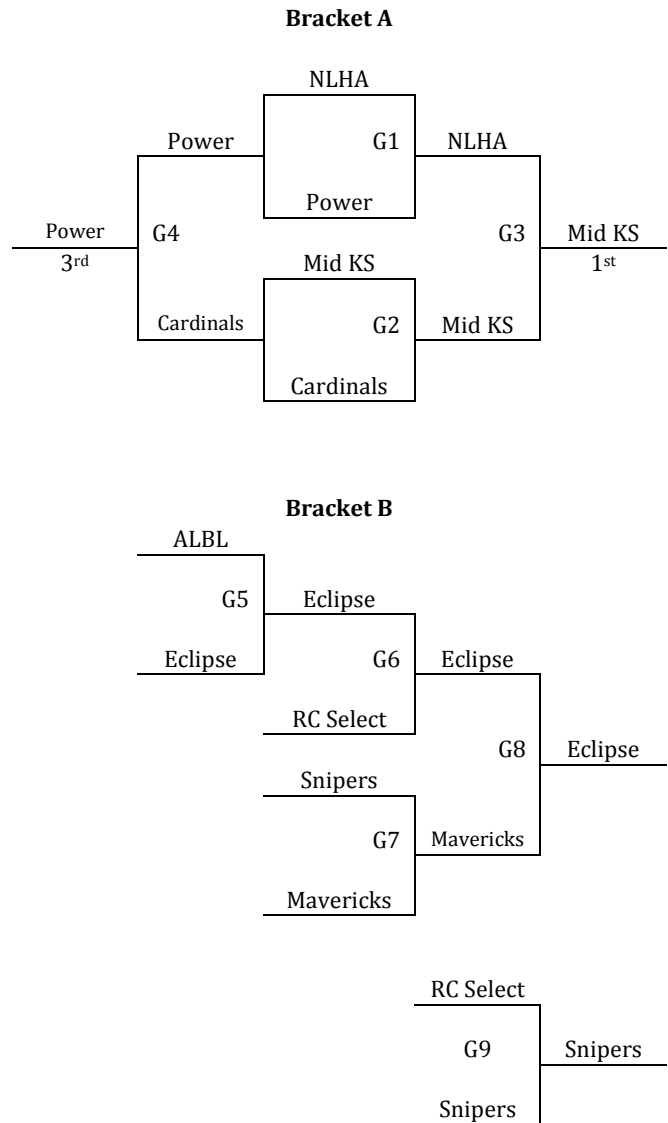

All games played at the Fast Forward Facility
 5260 N Toler Drive Bel Aire, KS 67226

Wichita, KS – MAYB
 May 16-17, 2015

5th/6th Grade Girls

Pool A	W	L
1. KS NLHA ASICS Wheatley – 5 th	II	I
2. Purple Thunder – 6 th		III
3. Smoky Valley Vikings – 6 th	III	
4. Lady Oz Elite – 5 th	I	II

All teams to Bracket

Tie Breaker – 2 way tie = Head to Head, 3 way tie = coin flip

Saturday	Court 1	Court 2	Court 3	Court 4
10:00	1-2	3-4	-	-
11:00	-	-	-	-
12:00	1-3	2-4	-	-
1:00	-	-	-	-
2:00	-	-	-	-
3:00	1-4	2-3	-	-
4:00	-	-	-	-
5:00	-	-	-	-
6:00	-	-	-	-
Sunday	Court 1	Court 2	Court 3	Court 4
10:00	-	-	G1	G2
11:00	-	-	-	-
12:00	-	-	G3	G4
1:00	-	-	-	-
2:00	-	-	-	-
3:00	-	-	-	-

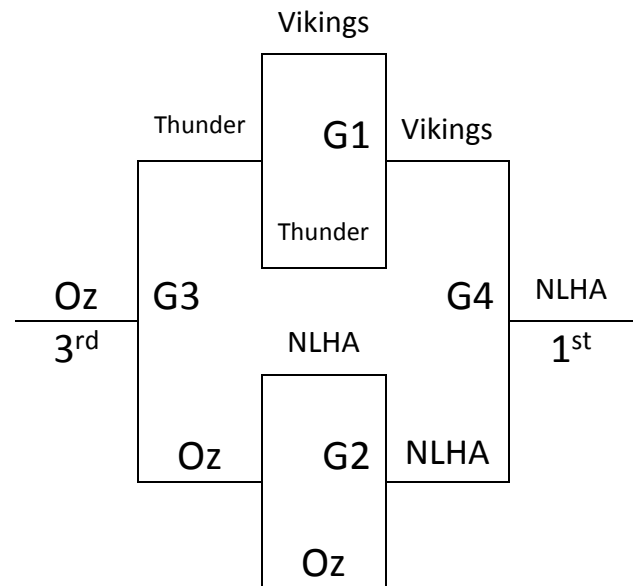

**All games played at the Fast Forward Facility
 5260 N Toler Drive Bel Aire, KS 67226**

Wichita, KS – MAYB
 May 16-17, 2015

7th Grade Girls

Pool A	W	L
1. Wichita Dream Team	III	
2. KS NLHA ASICS Lumbert		III
3. Kansas Lady Huskies	I	II
4. Potential Players 2020	II	I

All teams to Bracket

Tie Breaker – 2 way tie = Head to Head, 3 way tie = coin flip

Saturday	Court 1	Court 2	Court 3	Court 4
10:00	-	-	-	-
11:00	1-2	3-4	-	-
12:00	-	-	-	-
1:00	1-3	2-4	-	-
2:00	-	-	-	-
3:00	-	-	-	-
4:00	-	-	-	-
5:00	1-4	2-3	-	-
6:00	-	-	-	-
Sunday	Court 1	Court 2	Court 3	Court 4
10:00	-	-	-	-
11:00	-	-	-	-
12:00	-	-	-	-
1:00	-	-	G1	G2
2:00	-	-	-	-
3:00	-	-	G3	G4

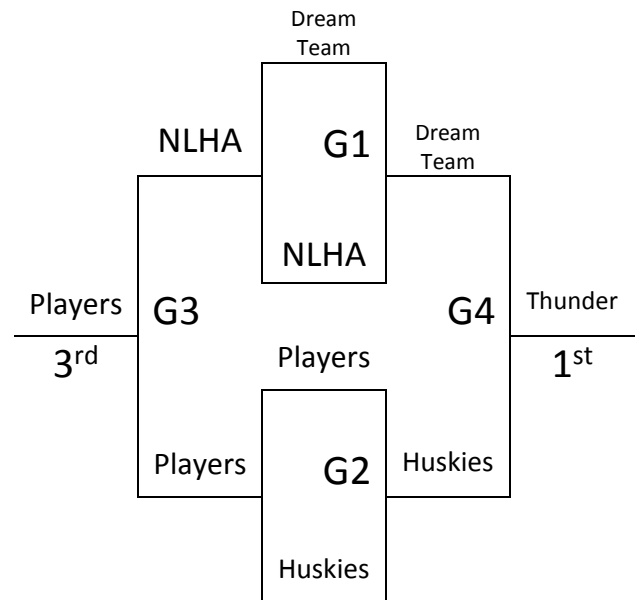

**All games played at the Fast Forward Facility
 5260 N Toler Drive Bel Aire, KS 67226**

Wichita, KS – MAYB
 May 16-17, 2015

9th/10th Grade Girls

Pool A	<u>W</u>	<u>L</u>
1. Lady Oz Elite	II	I
2. KS NLHA ASICS Mayfield 2018		III
3. Team Work Oklahoma	II	I
4. Kansas Sparq	II	I

All teams to Bracket

Tie Breaker – 2 way tie = Head to Head, 3 way tie = coin flip

Saturday	Court 3	Court 4
10:00	-	-
11:00	-	-
12:00	-	-
1:00	-	-
2:00	1-2	3-4
3:00	-	-
4:00	1-3	2-4
5:00	-	-
6:00	1-4	2-3
Sunday	Court 3	Court 4
10:00	-	-
11:00	G1	G2
12:00	-	-
1:00	-	-
2:00	G3	G4
3:00	-	-

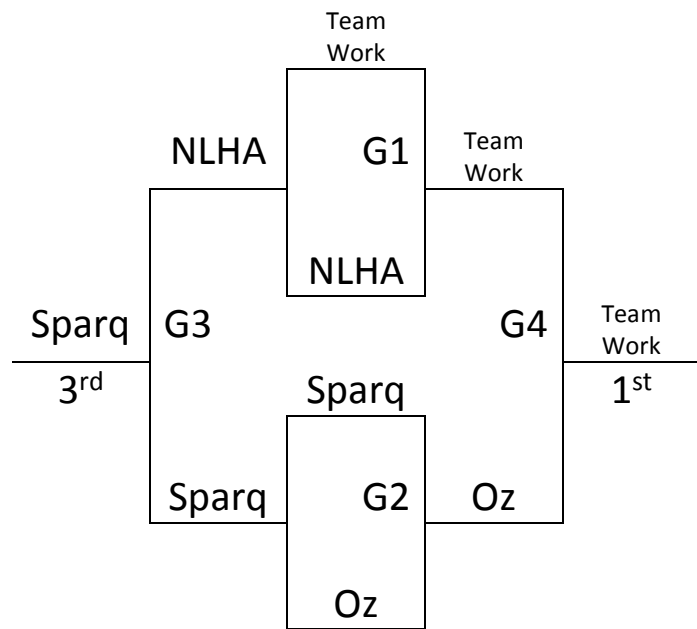

**All games played at the Fast Forward Facility
 5260 N Toler Drive Bel Aire, KS 67226**