

Hutchinson, KS – MAYB  
 July 12-14, 2013  
 3<sup>rd</sup>/4<sup>th</sup> Grade Boys

<b>Pool A</b>	<b>W</b>	<b>L</b>
1. Warriors		III
2. Wichita Defenders	I	II
3. Hutch Heat	III	
4. Storm	II	I

All Teams to bracket play

<b>Friday</b>	<b>NHS 1</b>	<b>NHS 2</b>	<b>RVMS</b>
6:00	2-3	-	-
7:00	-	-	-
8:00	2-4	-	-
9:00	-	-	-
<b>Saturday</b>	<b>NHS 1</b>	<b>NHS 2</b>	<b>RVMS</b>
8:00	1-2	3-4	-
9:00	-	-	-
10:00	-	-	1-3
11:00	-	-	-
12:00	-	-	1-4
1:00	-	-	-
2:00	-	-	-
3:00	-	-	-
4:00	-	-	-
5:00	-	-	-
6:00	-	-	-
7:00	-	-	-
8:00	-	-	-
9:00	-	-	-
<b>Sunday</b>	<b>NHS 1</b>	<b>NHS 2</b>	<b>RVMS</b>
8:00	3	4	-
9:00	-	-	-
10:00	2	3	-
11:00	-	-	-
12:00	-	-	-
1:00	-	-	-
2:00	-	-	-
3:00	-	-	-
4:00	-	-	-
5:00	-	-	-

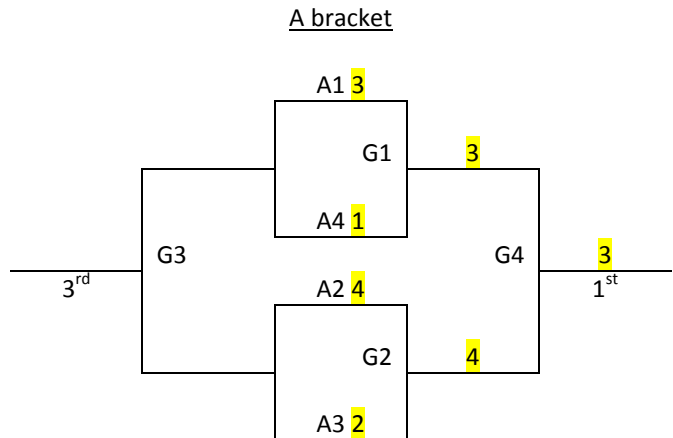

Hutchinson, KS – MAYB  
 July 12-14, 2013  
 4<sup>th</sup> Grade Boys

<b>Pool A</b>	<b>W</b>	<b>L</b>	<b>Pool B</b>	<b>W</b>	<b>L</b>
1. Hoisington Thunder	II	I	6. KS Players	II	II
2. River City Thunder	IIII		7. McPherson Top Dogs	IIII	
3. Wichita Mustangs	I	III	8. Kansas Lightning	I	III
4. Hutch Swish	I	III	9. Garden City Blue Devils		IIII
5. Hesston Swathers	II	II	10. Hutch Jr Celtics	III	I

<b>Friday</b>	<b>Morgan</b>
6:00	3-5
7:00	1-4
8:00	8-10
9:00	6-9
<b>Saturday</b>	<b>Morgan</b>
8:00	7-10
9:00	6-8
10:00	7-9
11:00	6-10
12:00	7-8
1:00	9-10
2:00	2-5
3:00	1-3
4:00	2-4
5:00	1-5
6:00	2-3
7:00	4-5
8:00	1-2
9:00	3-4
<b>Sunday</b>	<b>Morgan</b>
8:00	6-7
9:00	8-9
10:00	G1 (2)
11:00	G2 (10)
12:00	G3 (6)
1:00	G4 (4)
2:00	G5 (3)
3:00	-
4:00	-
5:00	-

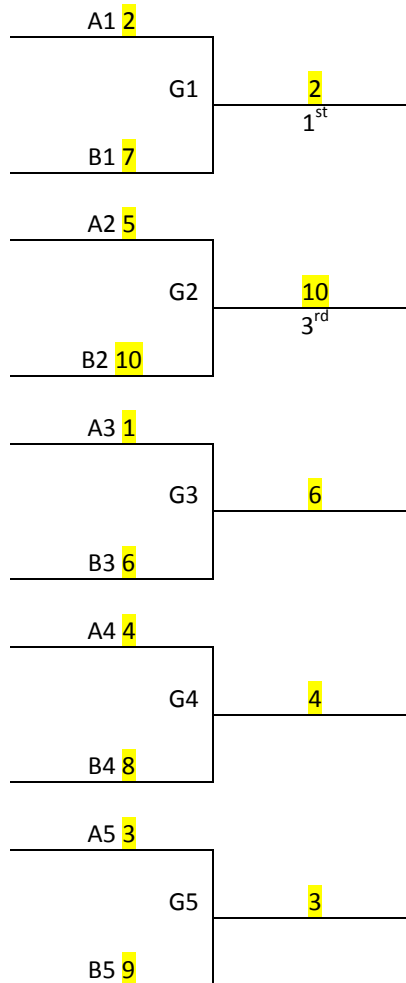

Hutchinson, KS – MAYB  
 July 12-14, 2013  
 5<sup>th</sup>/6<sup>th</sup> Grade Boys

<b>Pool A</b>	<b>W</b>	<b>L</b>
1. Hutch Jr Celtics		III
2. Wichita Celtics	III	
3. Buhler Crusaders	II	I
4. Maize Hawks	I	II

All Teams to bracket play

<b>Friday</b>	<b>HMS 7</b>
6:00	-
7:00	1-3
8:00	-
9:00	1-4
<b>Saturday</b>	<b>HMS 7</b>
8:00	-
9:00	-
10:00	2-3
11:00	-
12:00	-
1:00	1-2
2:00	3-4
3:00	-
4:00	-
5:00	-
6:00	2-4
7:00	-
8:00	-
9:00	-
<b>Sunday</b>	<b>HMS 7</b>
8:00	G1
9:00	G2
10:00	-
11:00	-
12:00	-
1:00	G3
2:00	G4
3:00	-
4:00	-
5:00	-

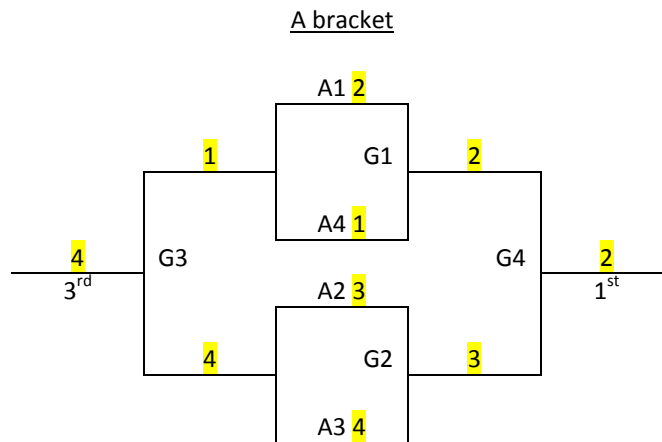

Hutchinson, KS – MAYB  
 July 12-14, 2013  
 6<sup>th</sup> Grade Boys

<u>Pool A</u>	<u>W</u>	<u>L</u>	<u>Pool B</u>	<u>W</u>	<u>L</u>
1. KS Players	I	I	4. SWK Thunder		II
2. Mid Kansas	II		5. Mid KS Elite	II	
3. Wichita Bulls		II	6. BGC Allstars	I	I

All teams advance to a seeding round on Saturday  
 Tie Breaker – 2 way tie = Head to Head, 3 way tie = coin flip

**Seeding Round**

- |   |   |
|---|---|
| <b>Game 1:</b> SEED #1 POOL A VS SEED #1 POOL B | Winner gets 1st seed, Loser gets 2nd seed |
| <b>Game 2:</b> SEED #2 POOL A VS SEED #2 POOL B | Winner gets 3rd seed, Loser gets 4th seed |
| <b>Game 3:</b> SEED #3 POOL A VS SEED #3 POOL B | Winner gets 5th seed, Loser gets 6th seed |

Friday	HMS 7
6:00	1-2
7:00	-
8:00	5-6
9:00	-
Saturday	HMS 7
8:00	1-3
9:00	4-5
10:00	-
11:00	2-3
12:00	4-6
1:00	-
2:00	-
3:00	2 G1
4:00	1 G2
5:00	3 G3
6:00	-
7:00	G4
8:00	1 G5
9:00	-
Sunday	HMS 7
8:00	-
9:00	-
10:00	6 G8
11:00	2 G6
12:00	5 G7
1:00	-
2:00	-
3:00	G9
4:00	G10
5:00	-

Hutchinson, KS – MAYB  
 July 12-14, 2013  
 6<sup>th</sup> Grade Boys - Continued

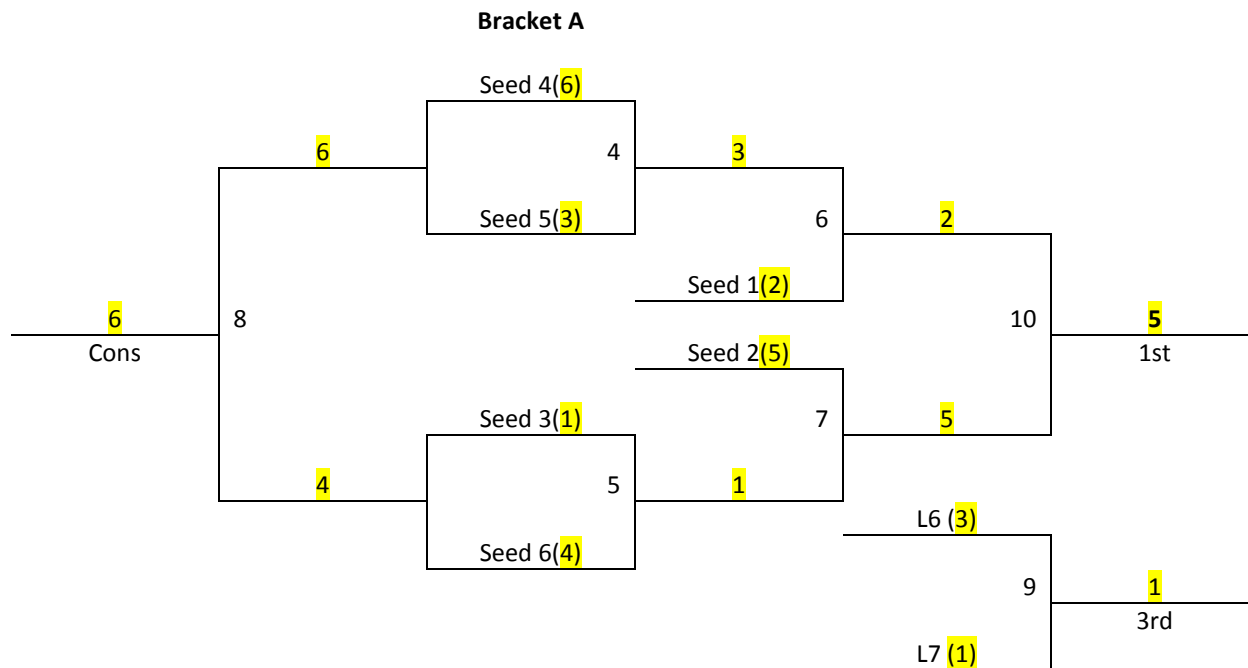

# Hutchinson, KS – MAYB

July 12-14, 2013

7<sup>th</sup> Grade Boys

<b>Pool A</b>	<b>W</b>	<b>L</b>	<b>Pool B</b>	<b>W</b>	<b>L</b>
1. I-135 Fusion	IIII		6. Holcomb Ballerz	II	II
2. Buhler Swish	II	II	7. C.S. Elite		IIII
3. Andover Trojans		IIII	8. NCK Celtics	I	III
4. Mel Hambelton Shock Elite	III	I	9. Wichita Clippers	III	I
5. Wichita Angels	I	III	10. Wichita Nets	IIII	

<b>Friday</b>	<b>HMS 8</b>
6:00	3-5
7:00	1-4
8:00	8-10
9:00	6-9
<b>Saturday</b>	<b>HMS 8</b>
8:00	2-5
9:00	1-3
10:00	2-4
11:00	1-5
12:00	2-3
1:00	4-5
2:00	1-2
3:00	3-4
4:00	7-10
5:00	6-8
6:00	7-9
7:00	6-10
8:00	7-8
9:00	9-10
<b>Sunday</b>	<b>HMS 8</b>
8:00	6-7
9:00	8-9
10:00	G1
11:00	G2
12:00	G3
1:00	G4
2:00	G5
3:00	-
4:00	-
5:00	-

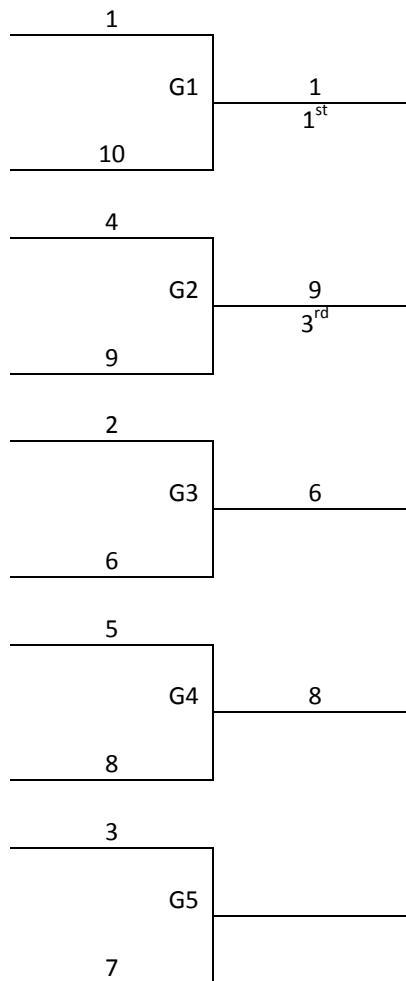

Hutchinson, KS – MAYB  
 July 12-14, 2013  
 8<sup>th</sup> Grade Boys Gold Division

<u>Pool A</u>	<u>W</u>	<u>L</u>	<u>Pool B</u>	<u>W</u>	<u>L</u>
1. Mid Kansas	I	I	4. Haven Wildcats		II
2. Andover Central Jaguars		II	5. Ducks	I	I
3. Wild-Tigaloos	II		6. NLHA	II	

All teams advance to a seeding round on Saturday  
 Tie Breaker – 2 way tie = Head to Head, 3 way tie = coin flip

**Seeding Round**

- Game 1:** SEED #1 POOL A VS SEED #1 POOL B      Winner gets 1st seed, Loser gets 2nd seed  
**Game 2:** SEED #2 POOL A VS SEED #2 POOL B      Winner gets 3rd seed, Loser gets 4th seed  
**Game 3:** SEED #3 POOL A VS SEED #3 POOL B      Winner gets 5th seed, Loser gets 6th seed

<b>Friday</b>	<b>SAC 1</b>	<b>SAC 2</b>	<b>North Gym</b>	<b>JV Gym</b>
6:00	-	-	-	-
7:00	-	-	-	-
8:00	-	-	-	-
9:00	-	-	-	-
<b>Saturday</b>	<b>SAC 1</b>	<b>SAC 2</b>	<b>North Gym</b>	<b>JV Gym</b>
8:00	-	-	-	4-5
9:00	-	-	-	2-3
10:00	-	-	-	4-6
11:00	-	-	-	1-2
12:00	-	-	-	5-6
1:00	-	-	-	1-3
2:00	-	-	-	-
3:00	-	-	-	-
4:00	-	-	-	-
5:00	-	-	-	-
6:00	-	-	-	-
7:00	-	-	-	G1
8:00	-	G3	-	G2
9:00	-	-	-	-
<b>Sunday</b>	<b>SAC 1</b>	<b>SAC 2</b>	<b>North Gym</b>	<b>JV Gym</b>
8:00	-	-	-	-
9:00	-	-	-	-
10:00	G4	G5	-	-
11:00	G8	-	-	-
12:00	-	-	-	-
1:00	-	-	-	-
2:00	-	-	-	-
3:00	G6	G7	-	-
4:00	-	-	-	-
5:00	G9	G10	-	-

Hutchinson, KS – MAYB  
 July 12-14, 2013  
 8<sup>th</sup> Grade Boys Gold Division - Continued

**Bracket A**

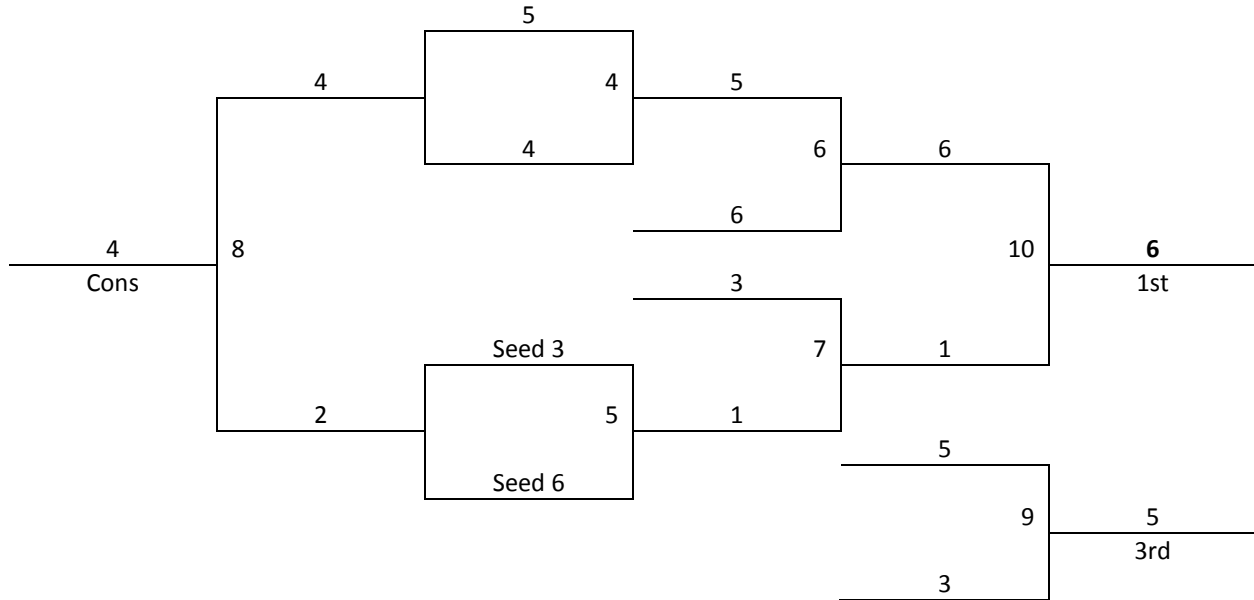



Hutchinson, KS – MAYB  
 July 12-14, 2013  
 8<sup>th</sup> Grade Boys Blue Division

<u>Pool A</u>	<u>W</u>	<u>L</u>	<u>Pool B</u>	<u>W</u>	<u>L</u>
1. Wichita Jags	II		4. Maize Thunder	II	
2. Cimarron	I	I	5. Hoisington	I	I
3. Wichita Angels		II	6. Augusta Orioles		II

All teams advance to a seeding round on Saturday  
 Tie Breaker – 2 way tie = Head to Head, 3 way tie = coin flip

**Seeding Round**

- Game 1:** SEED #1 POOL A VS SEED #1 POOL B      Winner gets 1st seed, Loser gets 2nd seed  
**Game 2:** SEED #2 POOL A VS SEED #2 POOL B      Winner gets 3rd seed, Loser gets 4th seed  
**Game 3:** SEED #3 POOL A VS SEED #3 POOL B      Winner gets 5th seed, Loser gets 6th seed

<b>Friday</b>	<b>SAC 1</b>	<b>SAC 2</b>	<b>North Gym</b>	<b>JV Gym</b>
6:00	-	-	-	1-3
7:00	-	-	-	4-5
8:00	-	-	-	1-2
9:00	-	-	-	4-6
<b>Saturday</b>	<b>SAC 1</b>	<b>SAC 2</b>	<b>North Gym</b>	<b>JV Gym</b>
8:00	-	-	-	-
9:00	-	-	-	-
10:00	-	-	-	-
11:00	-	-	-	-
12:00	-	-	-	-
1:00	-	-	-	-
2:00	-	-	-	2-3
3:00	-	-	-	5-6
4:00	-	-	-	Open
5:00	-	-	-	G1
6:00	-	-	-	G2
7:00	-	G3	-	-
8:00	-	-	-	-
9:00	-	G4	G5	-
<b>Sunday</b>	<b>SAC 1</b>	<b>SAC 2</b>	<b>North Gym</b>	<b>JV Gym</b>
8:00	-	-	-	-
9:00	-	-	-	-
10:00	-	-	-	-
11:00	-	-	-	G8
12:00	-	-	-	-
1:00	-	-	-	-
2:00	-	-	-	-
3:00	-	-	G6	G7
4:00	-	-	-	-
5:00	-	-	G9	G10

Hutchinson, KS – MAYB  
 July 12-14, 2013  
 8<sup>th</sup> Grade Boys Blue Division - Continued

**Bracket A**

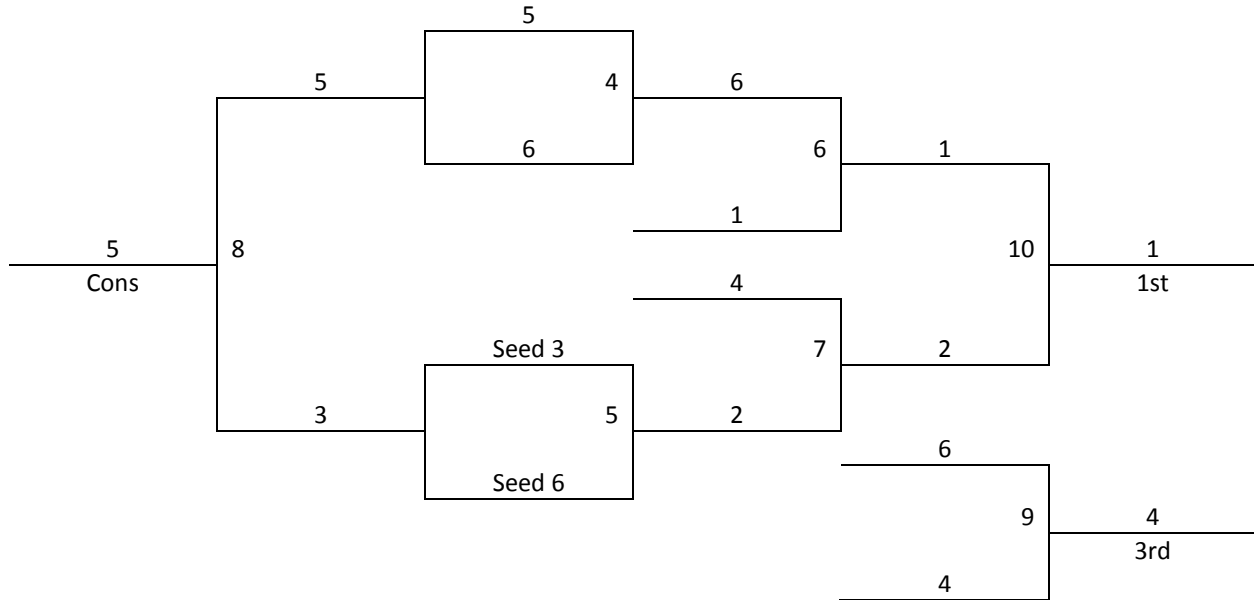

Hutchinson, KS – MAYB  
 July 12-14, 2013  
 9<sup>th</sup>/10<sup>th</sup> Grade Boys

<u>Pool A</u>	<u>W</u>	<u>L</u>	<u>Pool B</u>	<u>W</u>	<u>L</u>
1. Holcomb Longhorns	II	II	6. Central KS Storm	IIII	
2. Campus Colts	III	I	7. Republic County	III	I
3. Wichita Thunder	I	III	8. Kingman	I	III
4. CKE		IIII	9. Augusta Orioles	II	II
5. Circle T-Birds	IIII		10. Pratt Gold		IIII

Friday	SAC 1	SAC 2	North Gym	JV Gym		
6:00	-	-	3-5	-	5	
7:00	-	-	1-4	-	G1	5
8:00	-	-	2-5	-		1 <sup>st</sup>
9:00	-	-	1-3	-	6	
Saturday	SAC 1	SAC 2	North Gym	JV Gym		
8:00	-	-	8-10	-	2	
9:00	-	-	6-9	-	G2	2
10:00	-	-	7-10	-		3 <sup>rd</sup>
11:00	-	-	6-8	-	7	
12:00	-	-	7-9	-		
1:00	-	-	6-10	-	1	
2:00	-	-	7-8	-	G3	
3:00	-	-	9-10	-		1
4:00	-	-	2-4	-	9	
5:00	-	-	1-5	-		
6:00	-	-	2-3	-	3	
7:00	4-5	-	6-7	-	G4	
8:00	1-2	-	8-9	-		3
9:00	3-4	-	-	-	8	
Sunday	SAC 1	SAC 2	North Gym	JV Gym		
8:00	G3	G4	-	G5		
9:00	-	-	-	-	4	
10:00	-	-	G1	G2	G5	
11:00	-	-	-	-		4
12:00	-	-	-	-	10	
1:00	-	-	-	-		
2:00	-	-	-	-		
3:00	-	-	-	-		
4:00	-	-	-	-		
5:00	-	-	-	-		

Hutchinson, KS – MAYB  
 July 12-14, 2013  
 11<sup>th</sup>/12<sup>th</sup> Grade Boys Gold Division

<b>Pool A</b>	<b>W</b>	<b>L</b>	<b>Pool B</b>	<b>W</b>	<b>L</b>	<b>Pool C</b>	<b>W</b>	<b>L</b>
1. TX Rebels	I	II	5. Maize Eagles	III		9. Hutchinson Salthawks	II	I
2. Redhawks	III		6. Butler Starz	I	II	10. Holcomb Longhorns	III	
3. Great Bend		III	7. Republic County	II	I	11. Oz Elite Black		III
4. Wichita Crusaders	II	I	8. Haven Wildcats		III	12. Wichita Northwest	I	II

Top two seeds in each pool to bracket A, others to bracket B

<b>Friday</b>	<b>SAC 1</b>	<b>SAC 2</b>	<b>North Gym</b>	<b>JV Gym</b>
6:00	9-10	-	-	-
7:00	11-12	-	-	-
8:00	5-6	-	-	-
9:00	1-4	-	-	-
				-
<b>Saturday</b>	<b>SAC 1</b>	<b>SAC 2</b>	<b>North Gym</b>	<b>JV Gym</b>
8:00	9-11	10-12		
9:00	5-7	6-8	-	-
10:00	1-2	3-4	-	-
11:00	10-11	9-12	-	-
12:00	5-8	6-7	-	-
1:00	1-3	2-4	-	-
2:00	-	-	-	-
3:00	2-3	7-8	-	-
4:00	-	-	-	-
5:00	-	-	-	-
6:00	-	-	-	-
7:00	-	-	-	-
8:00	-	-	-	-
9:00	-	-	-	-
<b>Sunday</b>	<b>SAC 1</b>	<b>SAC 2</b>	<b>North Gym</b>	<b>JV Gym</b>
8:00	-	-	-	-
9:00	G1	G2	G8	G9
10:00	-	-	-	-
11:00	-	G7	G14	-
12:00	-	-	-	-
1:00	G3	G4	G10	G11
2:00	-	-	-	-
3:00	-	-	-	-
4:00	G6	G5	G13	G12
5:00	-	-	-	-

Hutchinson, KS – MAYB  
 July 12-14, 2013  
 11<sup>th</sup>/12<sup>th</sup> Grade Boys Gold Division - Continued

**Bracket A**

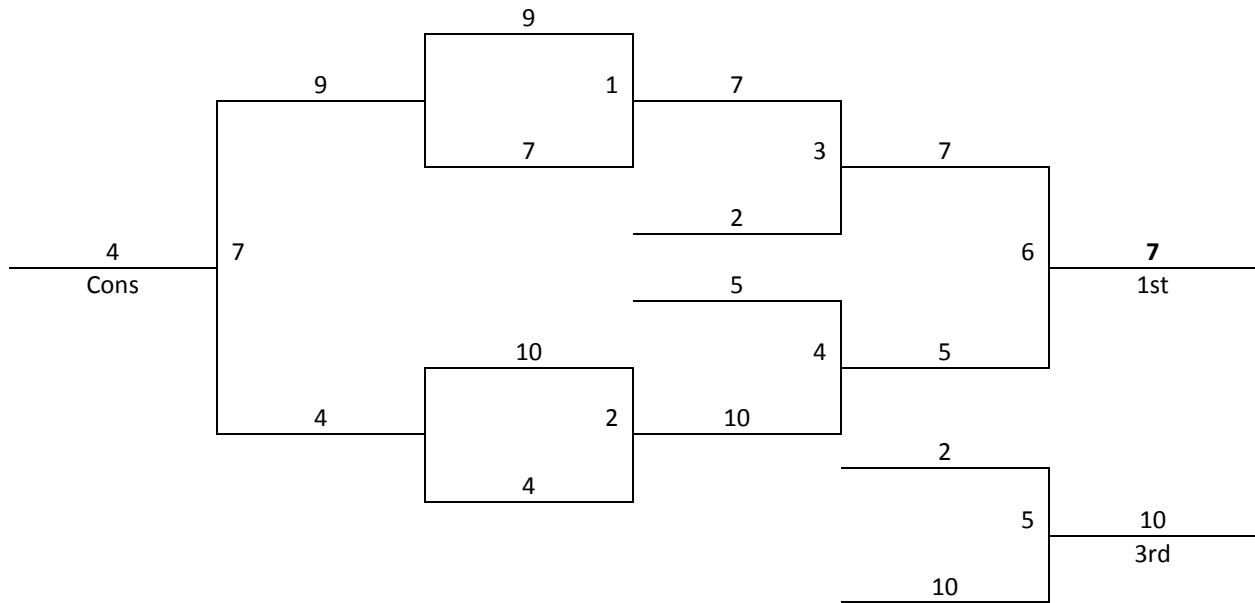

**Bracket B**

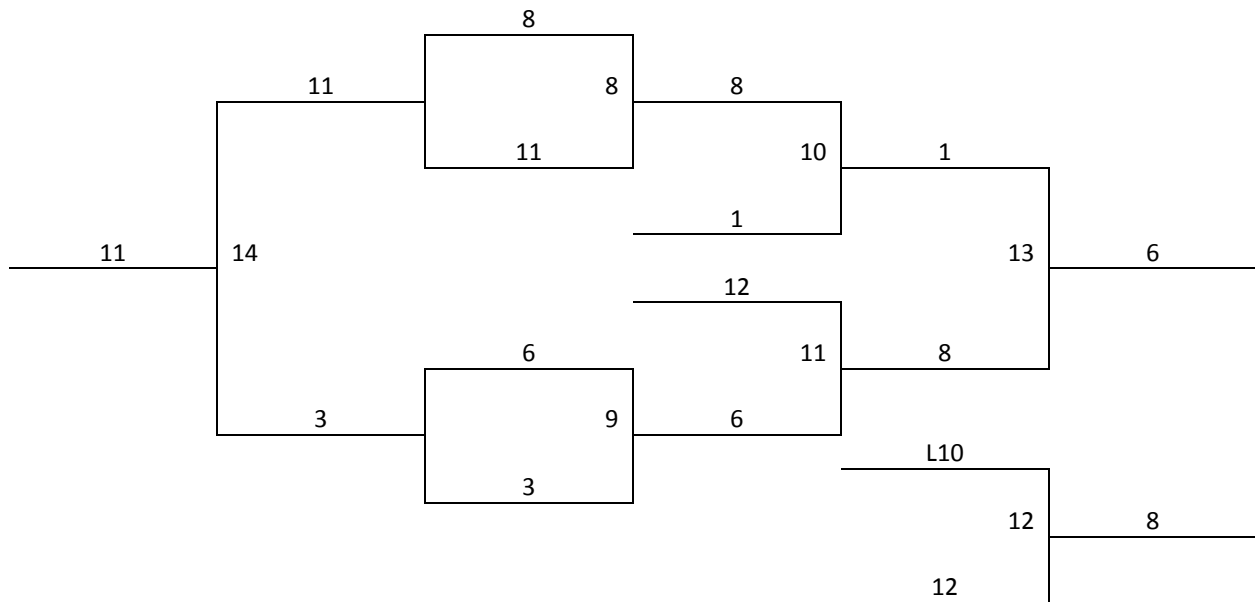

Hutchinson, KS – MAYB  
 July 12-14, 2013  
 11<sup>th</sup>/12<sup>th</sup> Grade Boys Blue Division

<u>Pool A</u>	<u>W</u>	<u>L</u>	<u>Pool B</u>	<u>W</u>	<u>L</u>
1. Falcons	I	II	5. Trinity Celtics		III
2. Hoisington	I	II	6. Sterling Black Bears	I	II
3. South Barber	II	I	7. Mulvane Suns	II	I
4. NWOK Has Beens	II	I	8. Pratt Green	III	

Top 2 teams in each Pool to Bracket A, Others to Bracket B.

Friday	SAC 1	SAC 2	North Gym	JV Gym
6:00	-	1-2	-	-
7:00	-	5-6	-	-
8:00	-	3-4	-	-
9:00	-	1-4	-	-
Saturday	SAC 1	SAC 2	North Gym	JV Gym
8:00	-	-	-	-
9:00	-	-	-	-
10:00	-	-	-	-
11:00	-	-	-	-
12:00	-	-	-	-
1:00	-	-	-	-
2:00	2-3	7-8	-	-
3:00	-	-	-	-
4:00	5-8	6-7	-	-
5:00	1-3	2-4	-	-
6:00	5-7	6-8	-	-
7:00	-	-	-	-
8:00	-	-	-	-
9:00	-	-	-	-
Sunday	SAC 1	SAC 2	North Gym	JV Gym
8:00	-	-	-	-
9:00	-	-	-	-
10:00	-	-	-	-
11:00	-	-	-	-
12:00	G1	G2	G5	G6
1:00	-	-	-	-
2:00	G4	G3	G8	G7
3:00	-	-	-	-
4:00	-	-	-	-
5:00	-	-	-	-

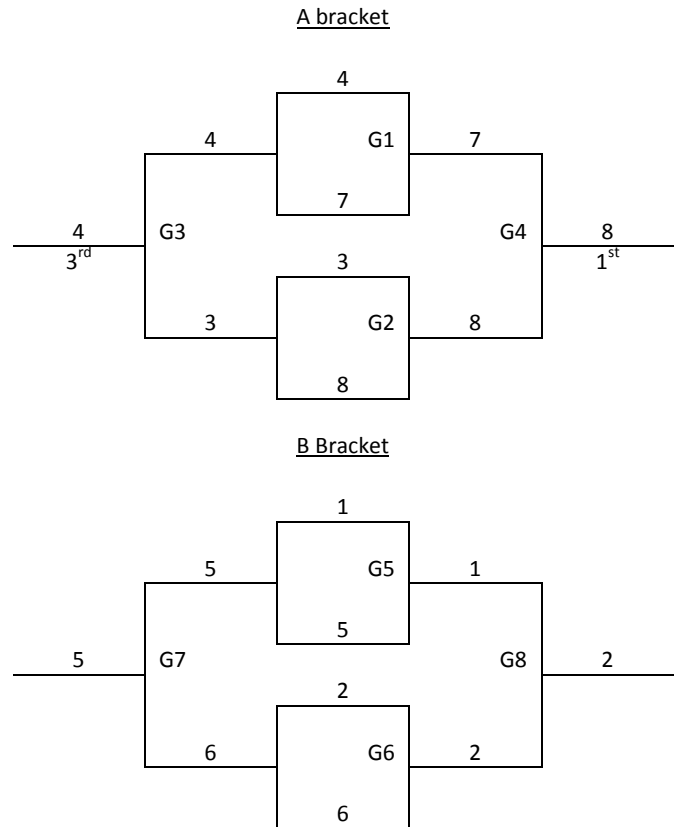

Hutchinson, KS – MAYB  
 July 12-14, 2013  
 3<sup>rd</sup>/4<sup>th</sup> Grade Girls

<b>Pool A</b>	<b>W</b>	<b>L</b>
1. Lady Fam Bam	II	I
2. Kingman Eagles	II	I
3. Junior Spartans	II	I
4. South Barber Dynamite		III

All Teams to bracket play

<b>Friday</b>	<b>NHS 1</b>	<b>NHS 2</b>
6:00	-	1-2
7:00	-	-
8:00	-	3-4
9:00	-	-
<b>Saturday</b>	<b>NHS 1</b>	<b>NHS 2</b>
8:00	-	-
9:00	1-3	2-4
10:00	-	-
11:00	1-4	2-3
12:00	-	-
1:00	-	-
2:00	-	-
3:00	-	-
4:00	-	-
5:00	-	-
6:00	-	-
7:00	-	-
8:00	-	-
9:00	-	-
<b>Sunday</b>	<b>NHS 1</b>	<b>NHS 2</b>
8:00	-	-
9:00	G1	G2
10:00	-	-
11:00	G3	G4
12:00	-	-
1:00	-	-
2:00	-	-
3:00	-	-
4:00	-	-
5:00	-	-

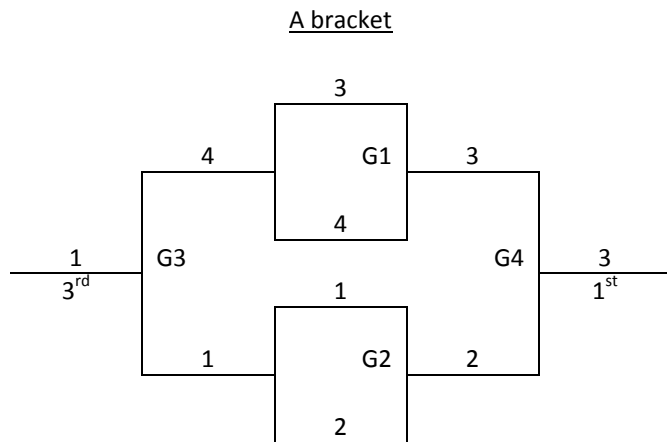

# Hutchinson, KS – MAYB

July 12-14, 2013

5<sup>th</sup>/6<sup>th</sup> Grade Girls

<u>Pool A</u>	<u>W</u>	<u>L</u>	<u>Pool B</u>	<u>W</u>	<u>L</u>
1. Triple Threat		II	4. Medicine Lodge/Attica	I	I
2. Wichita Crush	I	I	5. Kingman Eagles		II
3. Kansas Dream Team	II		6. Aftershock	II	

All teams advance to a seeding round on Saturday

Tie Breaker – 2 way tie = Head to Head, 3 way tie = coin flip

### Seeding Round

- Game 1:** SEED #1 POOL A VS SEED #1 POOL B      Winner gets 1st seed, Loser gets 2nd seed  
**Game 2:** SEED #2 POOL A VS SEED #2 POOL B      Winner gets 3rd seed, Loser gets 4th seed  
**Game 3:** SEED #3 POOL A VS SEED #3 POOL B      Winner gets 5th seed, Loser gets 6th seed

<b>Friday</b>	<b>NHS 1</b>	<b>NHS 2</b>	<b>RVMS</b>
6:00	-	-	-
7:00	1-3	4-6	-
8:00	-	-	-
9:00	-	-	-
<b>Saturday</b>	<b>NHS 1</b>	<b>NHS 2</b>	<b>RVMS</b>
8:00	-	-	-
9:00	-	-	-
10:00	1-2	4-5	-
11:00	-	-	-
12:00	-	-	-
1:00	2-3	5-6	-
2:00	-	-	-
3:00	G1	G2	-
4:00	G3	-	-
5:00	-	-	-
6:00	G4	G5	-
7:00	-	-	-
8:00	-	-	-
9:00	-	-	-
<b>Sunday</b>	<b>NHS 1</b>	<b>NHS 2</b>	<b>RVMS</b>
8:00	-	-	-
9:00	-	-	-
10:00	-	-	-
11:00	-	-	G8
12:00	G6	G7	-
1:00	-	-	-
2:00	G9	G10	-
3:00	-	-	-
4:00	-	-	-
5:00	-	-	-



Hutchinson, KS – MAYB  
 July 12-14, 2013  
 5<sup>th</sup>/6<sup>th</sup> Grade Girls - Continued

Bracket A

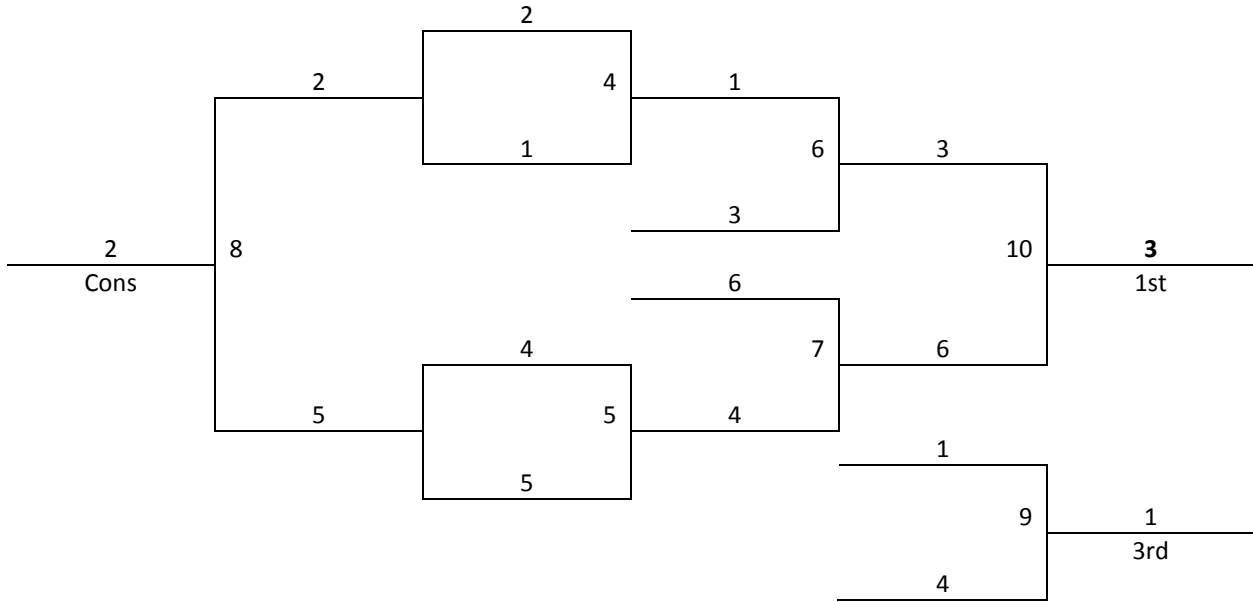

# Hutchinson, KS – MAYB

July 12-14, 2013

6<sup>th</sup>/7<sup>th</sup> Girls

<u>Pool A</u>	<u>W</u>	<u>L</u>	<u>Pool B</u>	<u>W</u>	<u>L</u>
1. Thunderbolts		II	4. Hutchinson Hawks	II	
2. Sedgwick Cardinals	I	I	5. Chase County Bulldogs		II
3. KS Dream Team 7 <sup>th</sup> B	II		6. MidKan Magic	I	I

All teams advance to a seeding round on Saturday

Tie Breaker – 2 way tie = Head to Head, 3 way tie = coin flip

### Seeding Round

- Game 1:** SEED #1 POOL A VS SEED #1 POOL B      Winner gets 1st seed, Loser gets 2nd seed  
**Game 2:** SEED #2 POOL A VS SEED #2 POOL B      Winner gets 3rd seed, Loser gets 4th seed  
**Game 3:** SEED #3 POOL A VS SEED #3 POOL B      Winner gets 5th seed, Loser gets 6th seed

<b>Friday</b>	<b>NHS 1</b>	<b>NHS 2</b>	<b>RVMS</b>
6:00	-	-	-
7:00	-	-	-
8:00	-	-	-
9:00	1-2	4-6	-
<b>Saturday</b>	<b>NHS 1</b>	<b>NHS 2</b>	<b>RVMS</b>
8:00	-	-	-
9:00	-	-	-
10:00	-	-	-
11:00	-	-	-
12:00	1-3	4-5	-
1:00	-	-	-
2:00	2-3	5-6	-
3:00	-	-	-
4:00	-	G1	-
5:00	G2	G3	-
6:00	-	-	-
7:00	G4	G5	-
8:00	-	-	-
9:00	-	-	-
<b>Sunday</b>	<b>NHS 1</b>	<b>NHS 2</b>	<b>RVMS</b>
8:00	-	-	-
9:00	-	-	-
10:00	-	-	-
11:00	-	-	-
12:00	-	-	G8
1:00	G6	G7	-
2:00	-	-	-
3:00	G10	G9	-
4:00	-	-	-
5:00	-	-	-

Hutchinson, KS – MAYB  
 July 12-14, 2013  
 6<sup>th</sup>/7<sup>th</sup> Grade Girls - Continued

Bracket A

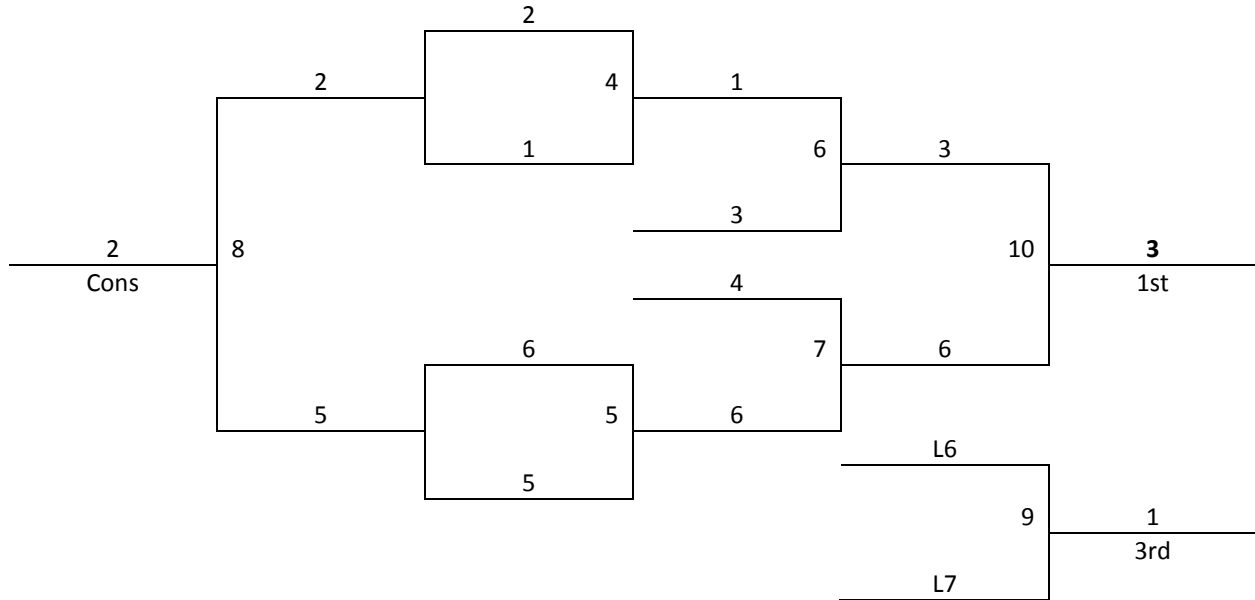

# Hutchinson, KS – MAYB

July 12-14, 2013

7<sup>th</sup> Grade Girls

<u>Pool A</u>	<u>W</u>	<u>L</u>
1. BGC Lady Allstars	IIII	
2. Kansas Fury	III	I
3. Hill City	I	III
4. Eclipse Black		IIII
5. Kingman Eagles	II	II

Friday	NHS 1	NHS 2	RVMS
6:00	-	-	-
7:00	-	-	-
8:00	-	-	-
9:00	-	-	-
Saturday	NHS 1	NHS 2	RVMS
8:00	-	-	3-5
9:00	-	-	1-4
10:00	-	-	-
11:00	-	-	2-5
12:00	-	-	-
1:00	-	-	1-3
2:00	-	-	2-4
3:00	-	-	1-5
4:00	-	-	2-3
5:00	-	-	4-5
6:00	-	-	1-2
7:00	-	-	3-4
8:00	-	-	-
9:00	-	-	-
Sunday	NHS 1	NHS 2	RVMS
8:00	-	-	G1
9:00	-	-	G3
10:00	-	-	G2
11:00	-	-	-
12:00	-	-	-
1:00	-	-	G4
2:00	-	-	G5
3:00	-	-	-
4:00	-	-	-
5:00	-	-	-

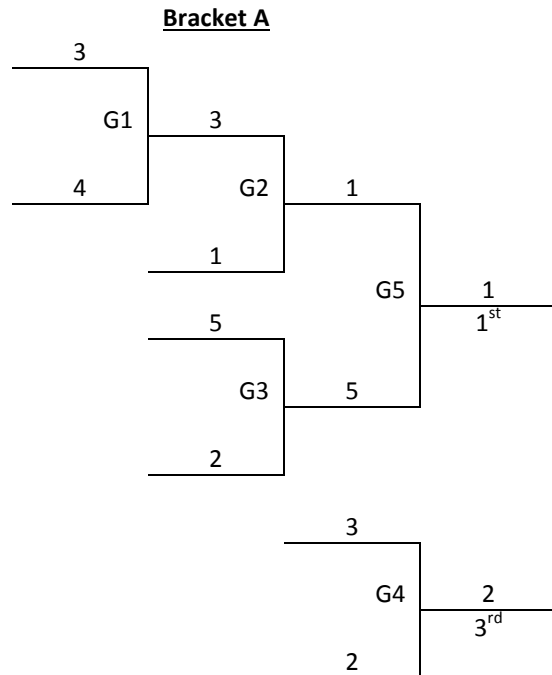

# Hutchinson, KS – MAYB

## July 12-14, 2013

### 8<sup>th</sup> Grade Girls

<u>Pool A</u>	<u>W</u>	<u>L</u>	<u>Pool B</u>	<u>W</u>	<u>L</u>
1. Minneola Shox		IIII	6. Holcomb Longhorns	II	I
2. Lady Wildcats	III	I	7. Wichita Grizzlies	I	II
3. Lady Jays	IIII		8. South Barber	II	I
4. Kingman Eagles	I	III	9. AHS Future	I	II
5. KS Dream Team 7th	II	II			

Top two in each pool to Bracket A, others to B

<b>Friday</b>	<b>SHS 1</b>	<b>SHS 2</b>	<b>SHS 3</b>
6:00	-	-	3-5
7:00	-	-	1-4
8:00	-	-	2-5
9:00	-	-	1-3
<b>Saturday</b>	<b>SHS 1</b>	<b>SHS 2</b>	<b>SHS 3</b>
8:00	-	-	2-4
9:00	-	-	1-5
10:00	-	-	2-3
11:00	-	-	4-5
12:00	-	-	1-2
1:00	-	-	3-4
2:00	-	-	-
3:00	6-7	8-9	-
4:00	-	-	-
5:00	6-8	7-9	-
6:00	-	-	-
7:00	6-9	7-8	-
8:00	-	-	-
9:00	-	-	-
<b>Sunday</b>	<b>SHS 1</b>	<b>SHS 2</b>	<b>SHS 3</b>
8:00	G1	G2	-
9:00	-	-	-
10:00	G3	G4	-
11:00	-	-	-
12:00	G5	G7	-
1:00	-	-	-
2:00	-	-	G6
3:00	-	-	G9
4:00	-	-	G8
5:00	-	-	-

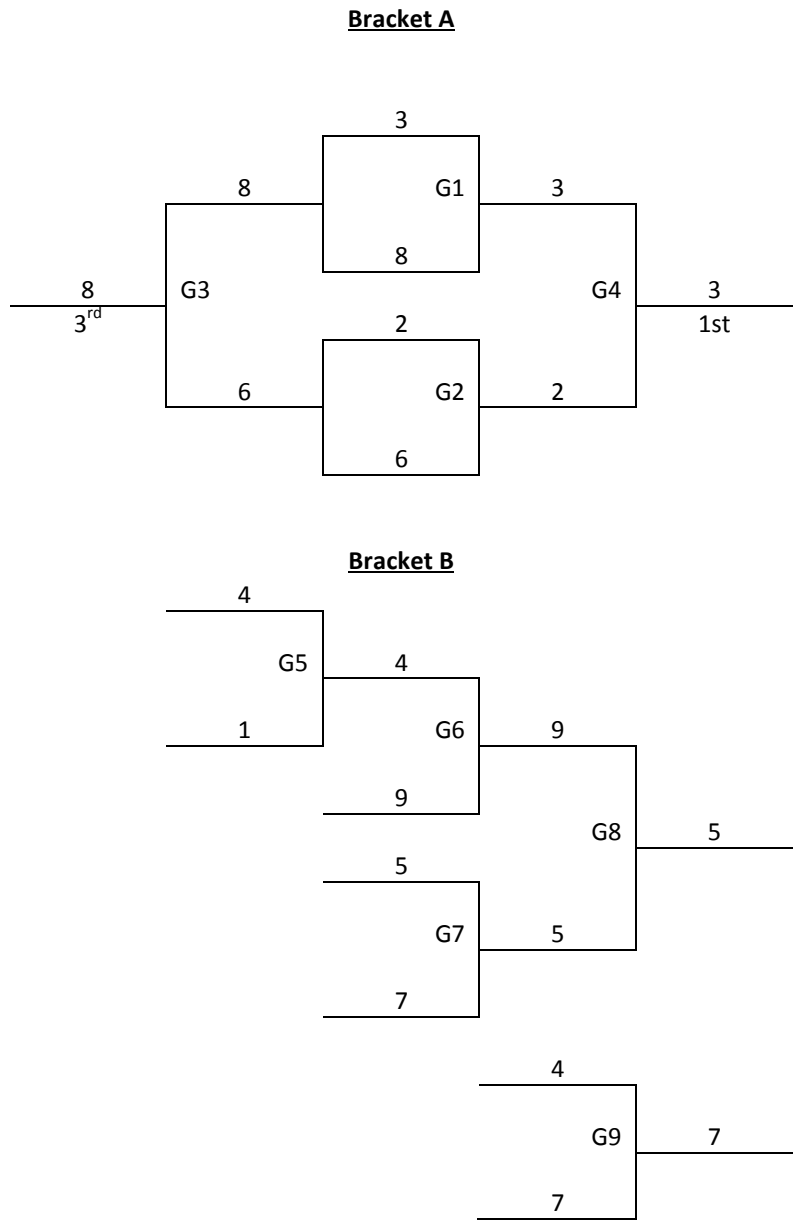

## July 12-14, 2013 9<sup>th</sup>/10<sup>th</sup> Grade Girls

Pool A	W	L	Pool B	W	L
1. KS Dream Team	III	-	6. Lady Trojans	-	III
2. Wichita Defenders	I	II	7. Tornados	III	-
3. Pratt	II	I	8. KS Lady Hawks	II	I
5. Kingman Eagles	-	III	9. St. John's Beloit	I	II

Top two in each pool to Bracket A, others to B

Friday	SHS 1	SHS 2	SHS 3
6:00	-	3-5	-
7:00	-	-	-
8:00	-	2-5	-
9:00	-	1-3	-
Saturday	SHS 1	SHS 2	SHS 3
8:00	-	-	-
9:00	-	1-5	-
10:00	-	2-3	-
11:00	-	-	-
12:00	-	1-2	-
1:00	-	-	-
2:00	6-7	8-9	-
3:00	-	-	-
4:00	6-8	7-9	-
5:00	-	-	-
6:00	6-9	7-8	-
7:00	-	-	-
8:00	-	-	-
9:00	-	-	-
Sunday	SHS 1	SHS 2	SHS 3
8:00	-	-	-
9:00	-	-	-
10:00	-	-	-
11:00	-	-	-
12:00	-	-	-
1:00	G1	G2	-
2:00	G6	G7	-
3:00	G3	G4	-
4:00	G8	G9	-
5:00	-	-	-

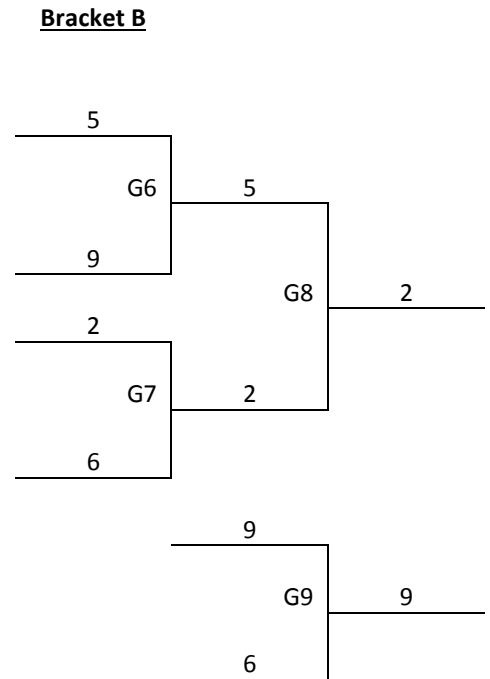
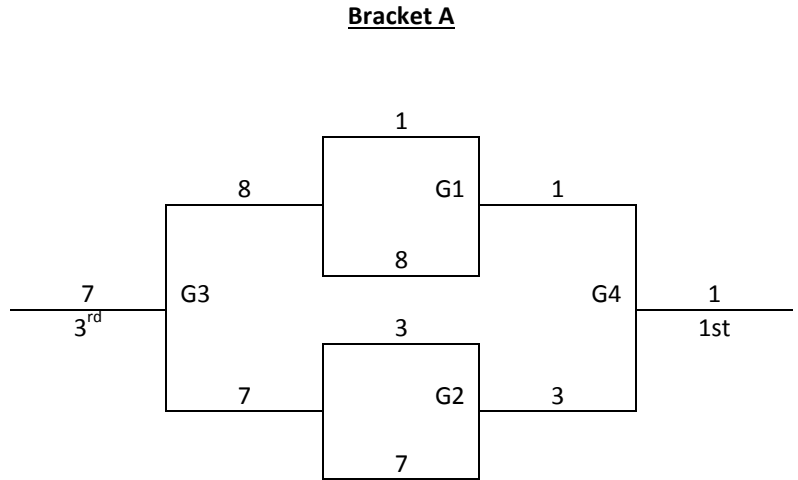

Hutchinson, KS – MAYB  
 July 12-14, 2013  
 11<sup>th</sup>/12<sup>th</sup> Grade Girls Gold Division

<u>Pool A</u>	<u>W</u>	<u>L</u>	<u>Pool B</u>	<u>W</u>	<u>L</u>
1. Waconda Lakers	III	I	6. KS Twisters	II	I
2. KS Dream Team	IIII		7. Lady Trojans 1		III
3. Butler Co. Elite	II	II	8. KS Lady Hawks	III	
4. Buhler Crusaders		IIII	9. St. John	I	II
5. South Barber	I	III			

<b>Friday</b>	<b>SHS 1</b>	<b>SHS 2</b>	<b>SHS 3</b>
6:00	3-5	-	-
7:00	1-4	-	-
8:00	2-5	-	-
9:00	1-3	-	-
<b>Saturday</b>	<b>SHS 1</b>	<b>SHS 2</b>	<b>SHS 3</b>
8:00	2-4	-	-
9:00	1-5	-	-
10:00	2-3	-	6-7
11:00	4-5	-	8-9
12:00	1-2	-	-
1:00	3-4	-	-
2:00	-	-	6-8
3:00	-	-	7-9
4:00	-	-	-
5:00	-	-	-
6:00	-	-	6-9
7:00	-	-	7-8
8:00	-	-	-
9:00	-	-	-
<b>Sunday</b>	<b>SHS 1</b>	<b>SHS 2</b>	<b>SHS 3</b>
8:00	-	-	G5
9:00	G1	G2	G6
10:00	-	-	G7
11:00	G3	G4	-
12:00	-	-	G8
1:00	-	-	G9
2:00	-	-	-
3:00	-	-	-
4:00	-	-	-
5:00	-	-	-

