

EL DORADO REC CENTER- **REVISED**

3rd/4th/5th Girls

	W	L
1. Wichita Dazzle		
2. Colwich Heat		
3. Ark City DARE Devils		
4. Hesston		

Court #1 Court #2 Court #3

Saturday, June 6

8:00		① vs 4	② vs 3	
9:00				
10:00				
11:00			3 vs ①	4 vs ②
12:00				
1:00				
2:00				1 vs ②
3:00		③ vs 4		
4:00				
5:00				
6:00				
7:00				
8:00				
9:00				

Sunday, June 7

SINGLE ELIMINATION TOURNAMENT

Sunday - El Dorado Rec
4th/5th Grade Girls - Bracket A

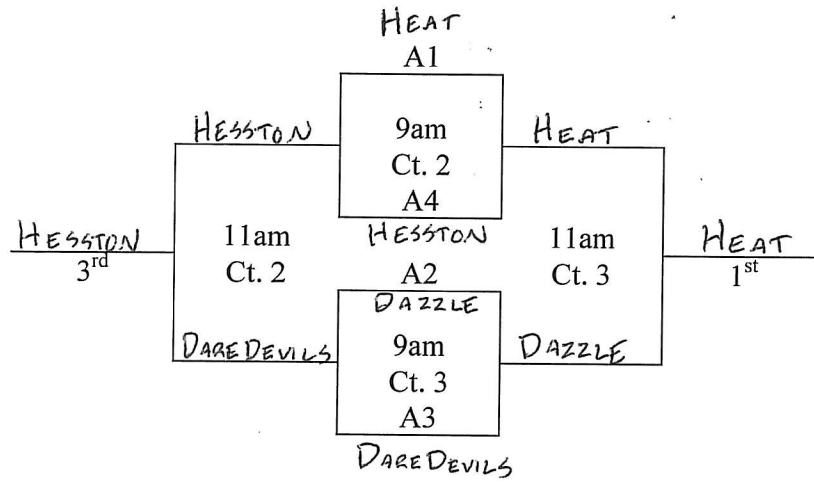

EL DORADO REC CENTER- **REVISED**

6th Grade Girls

1. Andover Gators
2. 9 Tigers - KS
3. Wichita Lady Blazers
4. Vikings - KS
5. Kansas Elite

W	L

Court #1 Court #2 Court #3

Saturday, June 6

8:00				
9:00			1 vs (2)	(3) vs 4
10:00				
11:00				
12:00				(5) vs 1
1:00	(2) vs 3			
2:00				
3:00				
4:00	1 vs (3)	(5) vs 4		
5:00				
6:00				
7:00			(2) vs 4	(5) vs 3
8:00				
9:00			(1) vs 4	2 vs (5)

Sunday, June 7

SINGLE ELIMINATION TOURNAMENT

Sunday – El Dorado Rec

6th Grade Girls – Bracket

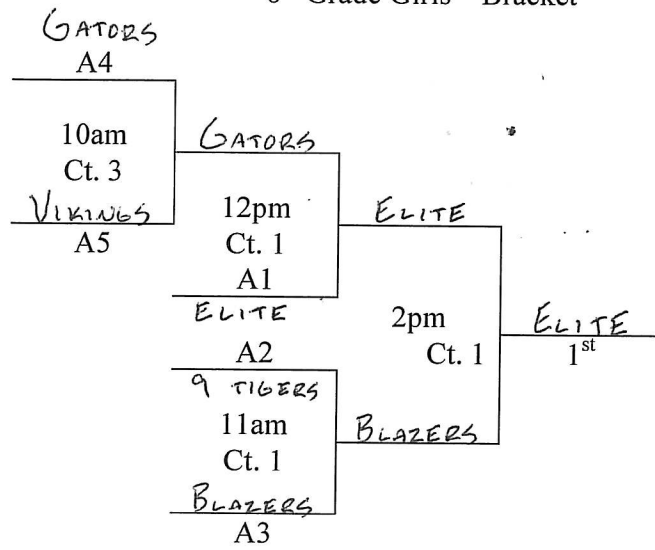

FARHA CENTER (SOUTH YMCA)- **REVISED**

7th/8th Grade Girls

POOL A

1. Wichita Sooners
2. Wichita Grizzlies
3. Andover Trojans (7th)
4. The Ballers - KS
5. Sumner County Defenders

POOL B

6. Andover Ballers
7. Rose Hill Rockets
8. Wichita Lady Crusaders
9. Andover Trojans (8th)

	W	L
1. Wichita Sooners		
2. Wichita Grizzlies		
3. Andover Trojans (7th)		
4. The Ballers - KS		
5. Sumner County Defenders		
6. Andover Ballers		
7. Rose Hill Rockets		
8. Wichita Lady Crusaders		
9. Andover Trojans (8th)		

Court #1 Court #2 Court #3 Court #4

Friday, June 5

6:00				
7:00				
8:00	2 vs 3	4 vs 5	6 vs 7	8 vs 9
9:00				

Court #1 Court #2 Court #3 Court #4

Saturday, June 6

8:00				
9:00				
10:00			1 vs 5	2 vs 4
11:00	6 vs 8	7 vs 9		
12:00				
1:00				
2:00	1 vs 2	3 vs 4	8 vs 7	6 vs 9
3:00				
4:00				
5:00				
6:00			2 vs 5	1 vs 3
7:00				
8:00	1 vs 4	3 vs 5		
9:00				

Sunday, June 7

2 SINGLE ELIMINATION TOURNAMENTS BASED ON RECORD

**Sunday – Farha Center
7th/8th Grade Girls Bracket A**

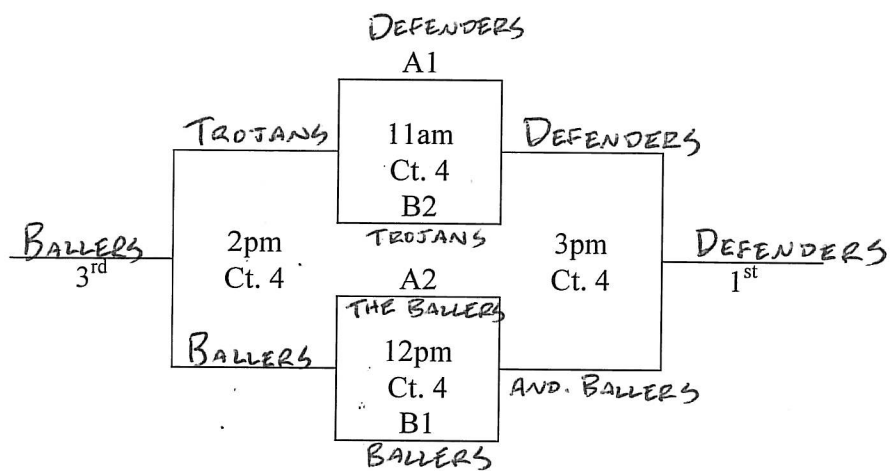

**RH ROCKETS 7th/8th Grade Girls – Bracket B
B4**

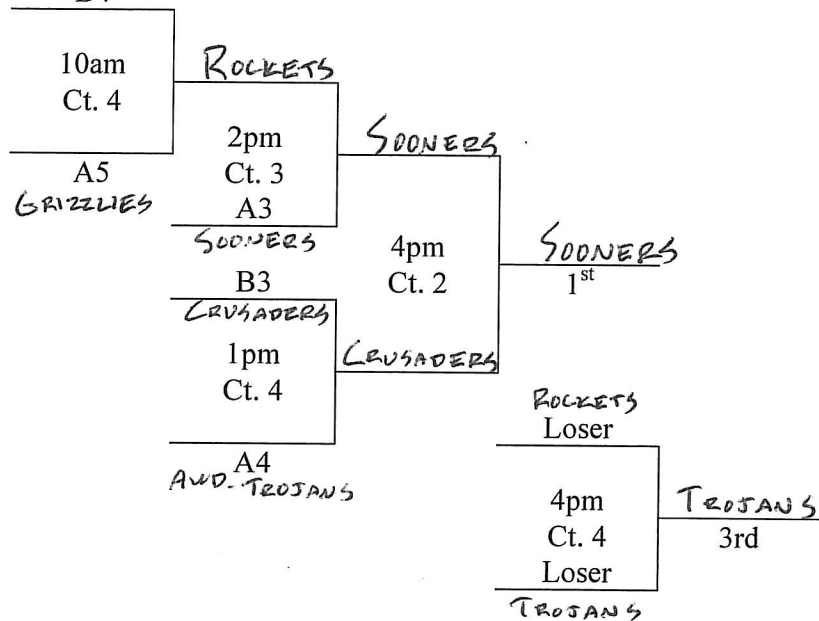

EL DORADO REC CENTER- ****REVISED****

9th/10th Girls

- 1. Hot Tamales - KS
- 2. Kansas Tornados
- 3. Wichita Wolfpack
- 4. Andover
- 5. Kansas Starz

W	L

Court #1 Court #2 Court #3

Saturday, June 6

8:00				
9:00				
10:00	① vs 2	3 vs ④		
11:00				
12:00				
1:00		5 vs ①	2 vs ③	
2:00				
3:00				
4:00			① vs 3	
5:00	5 vs ④			
6:00				
7:00				
8:00	② vs 4	5 vs ③		
9:00				

Sunday, June 7

8:00	① vs 4	② vs 5		
9:00				

SINGLE ELIMINATION TOURNAMENT

Sunday – El Dorado Rec

9/10th Grade Girls – Bracket

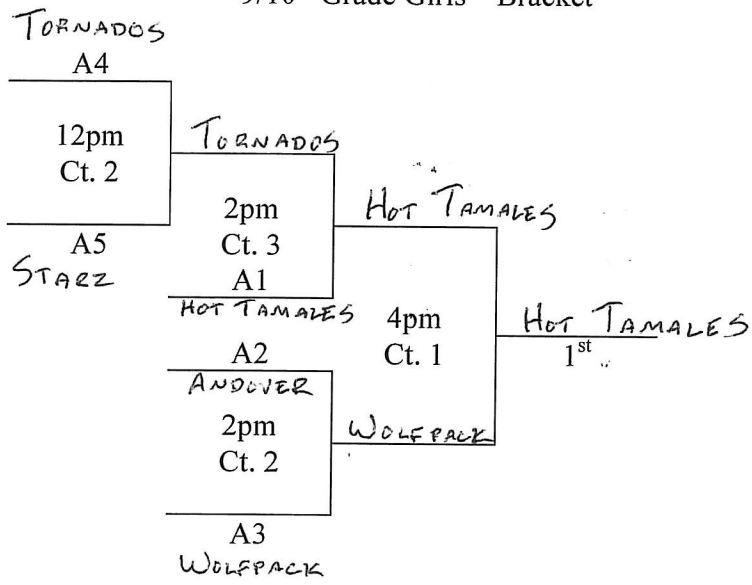

EL DORADO REC CENTER- ****REVISED****

11th/12th Girls

	W	L
1. Wichita Tigers		
2. Twin Lakes Stars - KS		
3. Newton Railers		
4. Skyline Thunderbirds		
5. Douglass Lady Dawgs 6		

Court #1 Court #2 Court #3

Saturday, June 6

8:00				
9:00				
10:00				① vs 2
11:00	3 vs ④			
12:00				
1:00				
2:00	5 vs ①	② vs 3		
3:00				
4:00				
5:00		① vs 3	⑤ vs 4	
6:00				
7:00				
8:00				② vs 4
9:00	⑤ vs 3			

Sunday, June 7

8:00				① vs 4
9:00	② vs 5			

SINGLE ELIMINATION TOURNAMENT

Sunday – El Dorado Rec

11/12th Grade Girls – Bracket

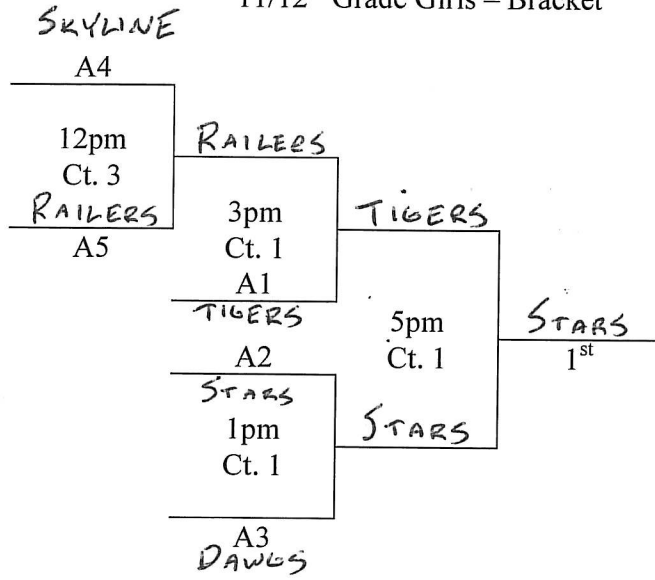

FARHA CENTER (SOUTH YMCA)- **REVISED**

5th/6th Grade Boys

1. Hawks - KS
2. Colwich Shockers
3. RH Rockets
4. Swoosh - KS
5. Newton Railers

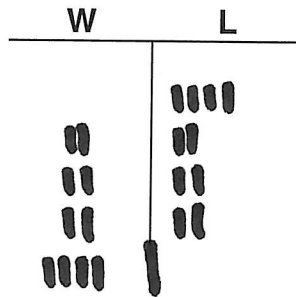

Court #1 Court #2 Court #3 Court #4

Friday, June 5

6:00		2 vs 5	3 vs 4		
7:00					
8:00					
9:00		5 vs 1	2 vs 3		

Court #1 Court #2 Court #3 Court #4

Saturday, June 6

8:00					
9:00					
10:00					
11:00			1 vs 4	5 vs 3	
12:00					
1:00					
2:00					
3:00					
4:00		3 vs 1	4 vs 2		
5:00					
6:00					
7:00			1 vs 2	4 vs 5	
8:00					
9:00					

Sunday, June 7

SINGLE ELIMINATION TOURNAMENT

Sunday – Farha Center

5/6th Grade Boys – Bracket

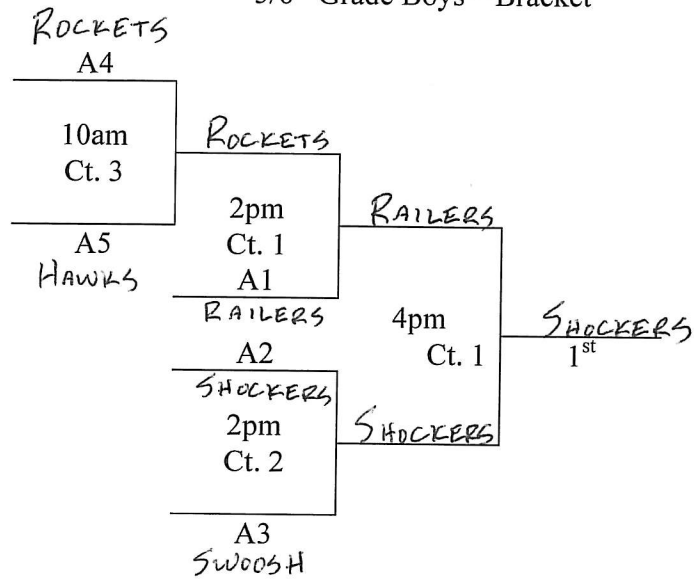

EL DORADO REC CENTER- **REVISED**

7th Grade Boys

- 1. Wichita Rebels
- 2. Kansas Jays
- 3. Andover Trojans
- 4. Augusta Orioles

W	L

Court #1 Court #2 Court #3

Saturday, June 6

8:00				① vs 4
9:00	② vs 3			
10:00				
11:00				
12:00	3 vs ①	4 vs ②		
1:00				
2:00				
3:00		① vs 2	③ vs 4	
4:00				
5:00				
6:00				
7:00				
8:00				
9:00				

Sunday, June 7

SINGLE ELIMINATION TOURNAMENT

Sunday - El Dorado Rec
7th Grade Boys - Bracket

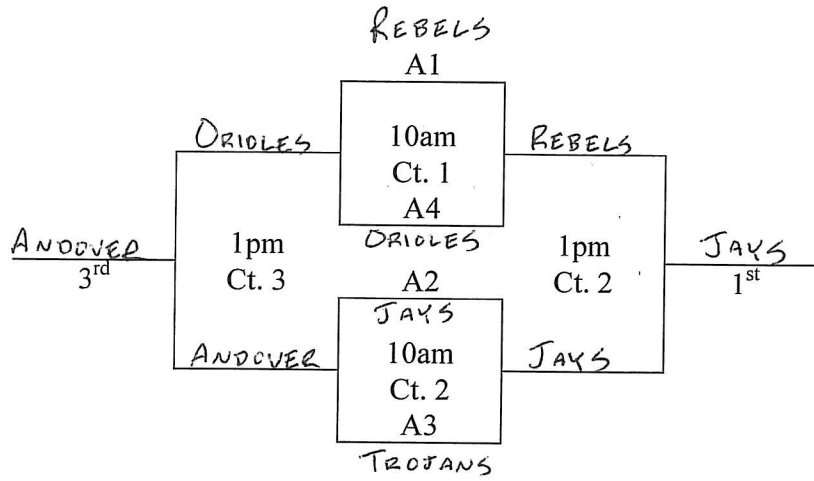

FARHA CENTER (SOUTH YMCA)- **REVISED**

8th Grade Boys

- 1. KS Elite 1st
- 2. Ta Town Heavyweights
- 3. Inferno - KS
- 4. Raptors - KS 3rd
- 5. Wichita 'Splosion 2nd
- 6. Andover Dawgs

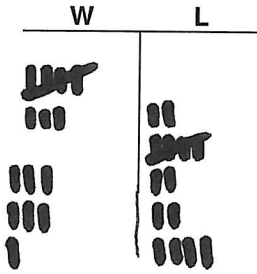

Court #1 Court #2 Court #3 Court #4

Friday, June 5

6:00					
7:00					
8:00					
9:00					

Court #1 Court #2 Court #3 Court #4

Saturday, June 6

8:00					1 vs 6
9:00	2 vs 5	3 vs 4			
10:00					
11:00					
12:00					5 vs 1
1:00	6 vs 4	2 vs 3			
2:00					
3:00					
4:00					
5:00	1 vs 4	5 vs 3	6 vs 2		
6:00					
7:00					
8:00					
9:00					

Sunday, June 7

8:00			3 vs 1	4 vs 2	
9:00	5 vs 6				
10:00					
11:00	1 vs 2	3 vs 6	4 vs 5		
12:00					
1:00					

ROUND ROBIN TOURNAMENT - BEST RECORD WINS

Tie Breaker - 2 way - Head to Head
3 way - +/-15 points

FARHA CENTER (SOUTH YMCA)- **REVISED**

9th/10th Grade Boys

- 1. Kansas Komets
- 2. McPherson ^{1st}
- 3. Newton Railers
- 4. Augusta Orioles
- 5. Wichita ^{2nd}
- 6. Central Jags ^{3rd}

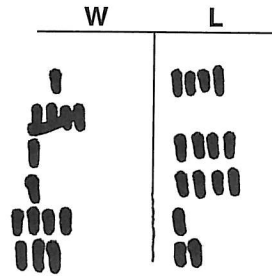

Court #1 Court #2 Court #3 Court #4

Friday, June 5

6:00				1 vs 6	2 vs 5
7:00					
8:00					
9:00				3 vs 4	5 vs 1

Court #1 Court #2 Court #3 Court #4

Saturday, June 6

8:00					
9:00					
10:00					
11:00					
12:00					
1:00				6 vs 4	2 vs 3
2:00					
3:00					
4:00					
5:00					1 vs 4
6:00	5 vs 3	6 vs 2			
7:00					
8:00					
9:00					

Sunday, June 7

8:00					
9:00			3 vs 1	4 vs 2	5 vs 6
10:00					
11:00					
12:00					
1:00	1 vs 2	3 vs 6	4 vs 5		

ROUND ROBIN TOURNAMENT - BEST RECORD WINS

Tie Breaker - 2 way - Head to Head
3 way - +/-15 points

FARHA CENTER (SOUTH YMCA)- **REVISED**

11th/12th Grade Boys

Pool A

- 1. Wichita Force
- 2. Valley Center
- 3. Central Jags
- 4. Northwest Grizzlies

Pool B

- 5. Crimson Pyre - KS
- 6. Newton Railers
- 7. Goddard
- 8. Rockhurst Nike Elite

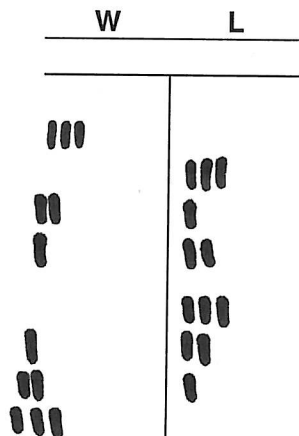

Court #1 Court #2 Court #3 Court #4

Friday, June 5

6:00							
7:00			1 vs 4	2 vs 3	5 vs 8	6 vs 7	
8:00							
9:00							

Court #1 Court #2 Court #3 Court #4

Saturday, June 6

8:00							
9:00					5 vs 7	8 vs 6	
10:00			1 vs 2	3 vs 4			
11:00							
12:00							
1:00							
2:00							
3:00			1 vs 3	2 vs 4	5 vs 6	7 vs 8	
4:00							
5:00							
6:00							
7:00							
8:00							
9:00							

Sunday, June 7

2 SINGLE ELIMINATION TOURNAMENTS BASED ON RECORD

Sunday - Farha Center
 11/12th Grade Boys - Bracket A

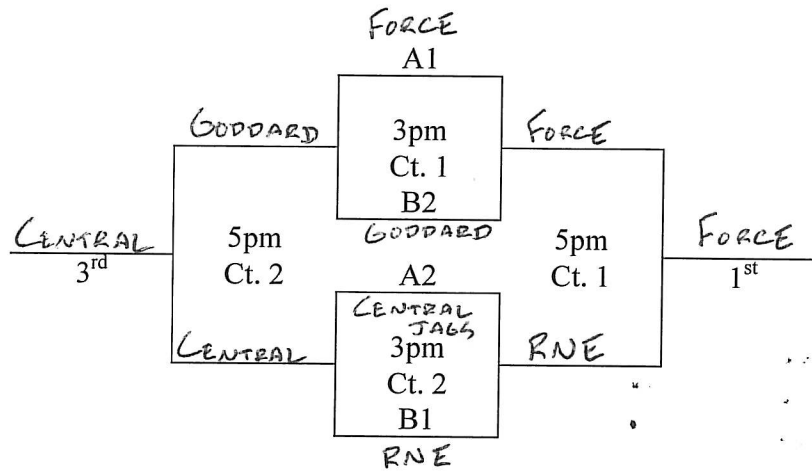

11/12th Grade Boys - Bracket B

