



**MAYB Winter Finale
March 26-27, 2011
Gym Directions**

Canton/Galva:

Canton High School - 506 South Kansas Canton, KS:

Exit I-135 Exit 60 east on Highway 56. Galva is approximately 5 miles east of McPherson. Canton is approximately 5 miles east of Galva. Both towns are very small. Approximately 12-15 miles from Hillsboro. McPherson, Canton/Galva and Hillsboro are all on Highway 56.

Canton/Galva Middle School - 116 South Santa Fe, Galva, KS: -

Exit I-135 Exit 60 east on Highway 56. Galva is approximately 5 miles east of McPherson. Canton is approximately 5 miles east of Galva. Both towns are very small.

Hesston:

Hesston High School – 200 N. Ridge Rd. – Hesston, KS 67062

Exit 40 west to Ridge Road. Turn South 5-6 blocks. High School is on the East side of the road.

Hesston MS: 100 N. Ridge Rd. – Hesston, KS 67062

Exit 40 west to Ridge Road. Turn south 5-6 blocks. Middle School is south of High School

Newton:

6 gyms located in Newton. 1 at Bethel College, 2 at Newton HS, 2 at Chisholm MS, and Lindley Hall
Use the following exits off I-135 for the listed gyms: Exit 31 St. Mary's, Chisholm. Exit 31 Lindley Hall,
Exit 34 Bethel, Newton HS,.

Chisholm MS: 900 E 1st St. – Newton, KS 67114

From the North: take I-135 South to Exit 31, take the access road to the First street exit, at the roundabout, exit right immediately, school will be down the street on the right. Drive behind the school on the SE side of the school. Enter through the NE doors of the new gym.

Lindley Hall behind Santa Fe Middle School 130 W. Broadway - 130 W. Broadway – Newton, KS 67114 - Exit 31, use roundabout, head west on Broadway. Coming from the north, take exit 31 use round about and follow the access road to Broadway. Head west on Broadway. Cross Main Street 1 block. Santa Fe MS is on north side of road. Turn north on Poplar.

Bethel College - 300 E. 27th – North Newton, KS 67117 - Exit 34 south on Main 2-3 blocks. School on east side of road.

Newton High School - 900 W. 12th – Newton, KS 67114 Exit 34 south on Main to 12th St. West on 12th high school on north side of road. Enter through North Entrance (on the back side of the school)

Moundridge:

1 gym located in Moundridge. Moundridge MS/HS.

Moundridge HS/MS – 526 E. Cole – Moundridge, KS - Exit 46 West. High School is on south side of road.

Halstead:

Halstead Middle School (2 gyms) – Halstead High School (2 gyms) – Same Campus

4 gyms located in Halstead. (520 W. 6th, Halstead, KS)

Take Highway 50 exit west from I-135. Take the Halstead exit by the cemetery. This road becomes Halstead Main Street. Stay on Main until 4 way stop. Turn West on 6th St. at the 4 way stop. You will see the schools on the south side of the road.

Gym Doors will open 30 minutes before the first game. Please do not expect to get into the gym before that time!



**MAYB Winter Finale
March 26-27, 2011
3rd Grade Boys**

| Pool A | W | L | Pool B | W | L |
|----------------------|----------|----------|-------------------------|----------|----------|
| 1. Wichita Hawks | | | 4. Mulvane Wildcats | | |
| 2. Garden Plain Owls | | | 5. Andover Bulls | | |
| 3. Barton Blazers | | | 6. Emporia Jr. Spartans | | |

All teams to Bracket
Tie Breaker – 2 way tie = Head to Head, 3 way tie = coin flip

| Saturday | Hesston MS |
|-----------------|-------------------|
| 8:00 | - |
| 9:00 | - |
| 10:00 | - |
| 11:00 | 1-2 |
| 12:00 | 4-5 |
| 1:00 | - |
| 2:00 | - |
| 3:00 | 2-3 |
| 4:00 | 4-6 |
| 5:00 | - |
| 6:00 | 1-3 |
| 7:00 | 5-6 |
| 8:00 | - |
| 9:00 | - |
| | |
| Sunday | Hesston MS |
| 8:00 | - |
| 9:00 | G1 |
| 10:00 | G2 |
| 11:00 | G3 |
| 12:00 | G4 |
| 1:00 | G5 |
| 2:00 | G6 |
| 3:00 | G7 |
| 4:00 | - |
| 5:00 | - |
| 6:00 | - |

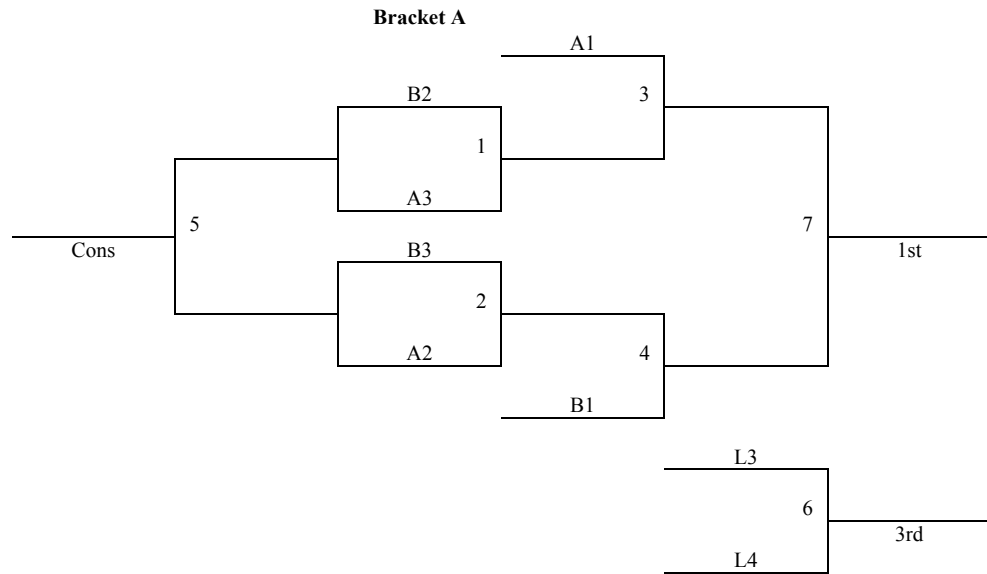

Hesston MS – Hesston Middle School – in Hesston, KS

Games will be played on 8.5ft goals and the 28.5 sized ball will be used.

Gym Doors will open 30 minutes before the first game. Please do not expect to get into the gym before that time!

MAYB Winter Finale
March 26-27, 2011
4th Grade Boys – Division I

| Pool A | W | L | Pool B | W | L |
|-----------------------|----------|----------|----------------------|----------|----------|
| 1. Baby Crunch | | | 4. KC Running Rebels | | |
| 2. Wichita Gamerz | | | 5. WCS D Up | | |
| 3. Sedgwick Cardinals | | | 6. Topeka Ice Storm | | |

| Pool C | W | L |
|----------------------|----------|----------|
| 7. MO Show-Me Bruins | | |
| 8. Top City | | |
| 9. JC Man Wildcats | | |

Top 2 teams from each pool to Bracket A, others to Bracket B
 Tie Breaker – 2 way – Head to Head, 3 way – Coin Flip

| Saturday | CG HS | CG MS |
|-----------------|--------------|--------------|
| 8:00 | - | - |
| 9:00 | - | - |
| 10:00 | - | - |
| 11:00 | - | - |
| 12:00 | 2-3 | 5-6 |
| 1:00 | 8-9 | - |
| 2:00 | - | - |
| 3:00 | - | 1-2 |
| 4:00 | 4-5 | 7-8 |
| 5:00 | - | - |
| 6:00 | - | - |
| 7:00 | 4-6 | 1-3 |
| 8:00 | 7-9 | - |
| 9:00 | - | - |
| | | |
| Sunday | CG HS | CG MS |
| 8:00 | G8 | - |
| 9:00 | G1 | - |
| 10:00 | G2 | - |
| 11:00 | G9 | - |
| 12:00 | G3 | - |
| 1:00 | G4 | - |
| 2:00 | G5 | - |
| 3:00 | G6 | - |
| 4:00 | G7 | - |
| 5:00 | - | - |
| 6:00 | - | - |

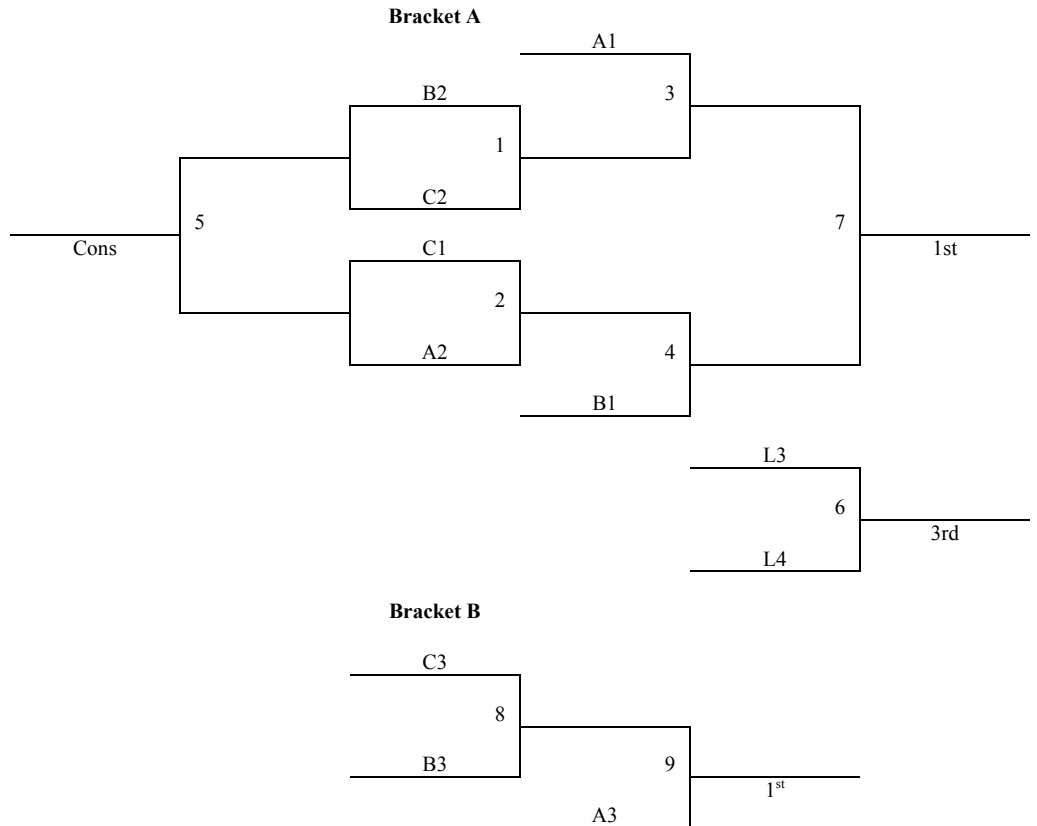

CG HS = Canton Galva High School – Canton, KS
 CG MS = Canton Galva Middle School – Galva, KS

Gym Doors will open 30 minutes before the first game. Please do not expect to get into the gym before that time!

MAYB Winter Finale
March 26-27, 2011
4th Grade Boys – Division II

| Pool A | W | L | Pool B | W | L |
|--------------------------|----------|----------|-------------------------|----------|----------|
| 1. BGC All Stars | | | 5. Emporia Jr. Spartans | | |
| 2. Wichita Celtics | | | 6. Andover Noles | | |
| 3. Hesston/Newton | | | 7. Waverly Thunder | | |
| 4. Ark City Goldtrotters | | | 8. Game On Prospects | | |

Top 2 teams in each Pool to Bracket A, Others to Bracket B.
Tie Breaker – 2 way tie = Head to Head, 3 way tie = coin flip

| Saturday | CG HS | CG MS |
|-----------------|--------------|--------------|
| 8:00 | - | - |
| 9:00 | - | - |
| 10:00 | 5-8 | 1-3 |
| 11:00 | 6-7 | 2-4 |
| 12:00 | - | - |
| 1:00 | - | 1-2 |
| 2:00 | 5-6 | 3-4 |
| 3:00 | 7-8 | - |
| 4:00 | - | - |
| 5:00 | 5-7 | 1-4 |
| 6:00 | 6-8 | 2-3 |
| 7:00 | - | - |
| 8:00 | - | - |
| 9:00 | - | - |
| | | |
| Sunday | CG HS | CG MS |
| 8:00 | - | - |
| 9:00 | - | G5 |
| 10:00 | - | G6 |
| 11:00 | - | G1 |
| 12:00 | - | G2 |
| 1:00 | - | G7 |
| 2:00 | - | G8 |
| 3:00 | - | G3 |
| 4:00 | - | G4 |
| 5:00 | - | - |
| 6:00 | - | - |

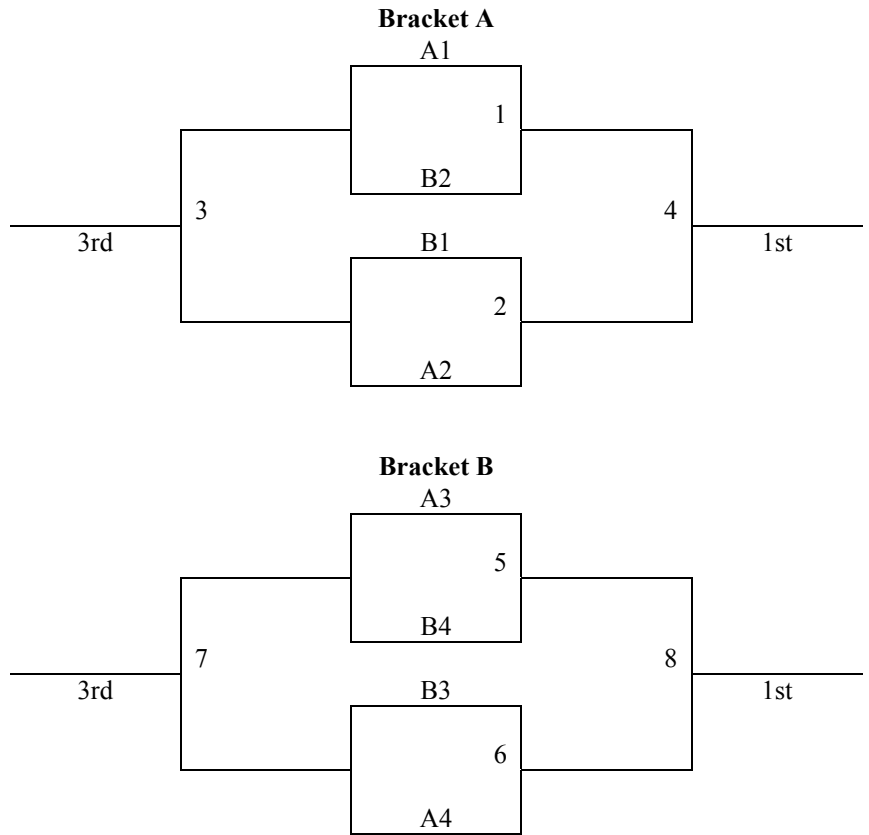

CG HS = Canton Galva High School – Canton, KS
CG MS = Canton Galva Middle School – Galva, KS

Gym Doors will open 30 minutes before the first game. Please do not expect to get into the gym before that time!



MAYB Winter Finale
March 26-27, 2011
5th Grade Boys

| Pool A | W | L | Pool B | W | L | Pool C | W | L |
|--------------------|----------|----------|-------------------|----------|----------|----------------------|----------|----------|
| 1. KS Select | | | 4. Top City | | | 7. Wichita Kings | | |
| 2. Osage Co. Stars | | | 5. Wichita Angels | | | 8. Wichita Hoopers | | |
| 3. Circle Swish | | | 6. Salina Swish | | | 9. Ark City Bulldogs | | |

| Pool D | W | L |
|----------------------------------|----------|----------|
| 10. Emporia Jr. Spartans - Black | | |
| 11. Ark City Dawgs | | |
| 12. Northern OK Heat | | |
| 13. Moundridge Wildcats | | |

Top 2 teams in each Pool to Bracket A, Others to Bracket B.
 Tie Breaker – 2 way tie = Head to Head, 3 way tie = coin flip

| Saturday | Chisholm1 | Chisholm 2 |
|-----------------|------------------|-------------------|
| 8:00 | - | - |
| 9:00 | 1-3 | 4-5 |
| 10:00 | 10-12 | 11-13 |
| 11:00 | 7-8 | 4-6 |
| 12:00 | 1-2 | 10-11 |
| 1:00 | 8-9 | 12-13 |
| 2:00 | 2-3 | 5-6 |
| 3:00 | 10-13 | 11-12 |
| 4:00 | 7-9 | Open |
| 5:00 | G1 | G3 |
| 6:00 | G2 | G4 |
| 7:00 | G14 | G12 |
| 8:00 | - | - |
| 9:00 | - | - |
| Sunday | Chisholm1 | Chisholm 2 |
| 8:00 | - | - |
| 9:00 | - | - |
| 10:00 | G7 | G5 |
| 11:00 | G8 | G6 |
| 12:00 | G13 | - |
| 1:00 | G10 | G9 |
| 2:00 | - | - |
| 3:00 | G11 | G15 |
| 4:00 | G16 | - |
| 5:00 | - | - |
| 6:00 | - | - |

Chisholm 1- Chisholm Middle School Court 1

Chisholm 2- Chisholm Middle School Court 2

Gym Doors will open 30 minutes before the first game. Please do not expect to get into the gym before that time!

MAYB Winter Finale
March 26-27, 2011
5th Grade Boys – Continued

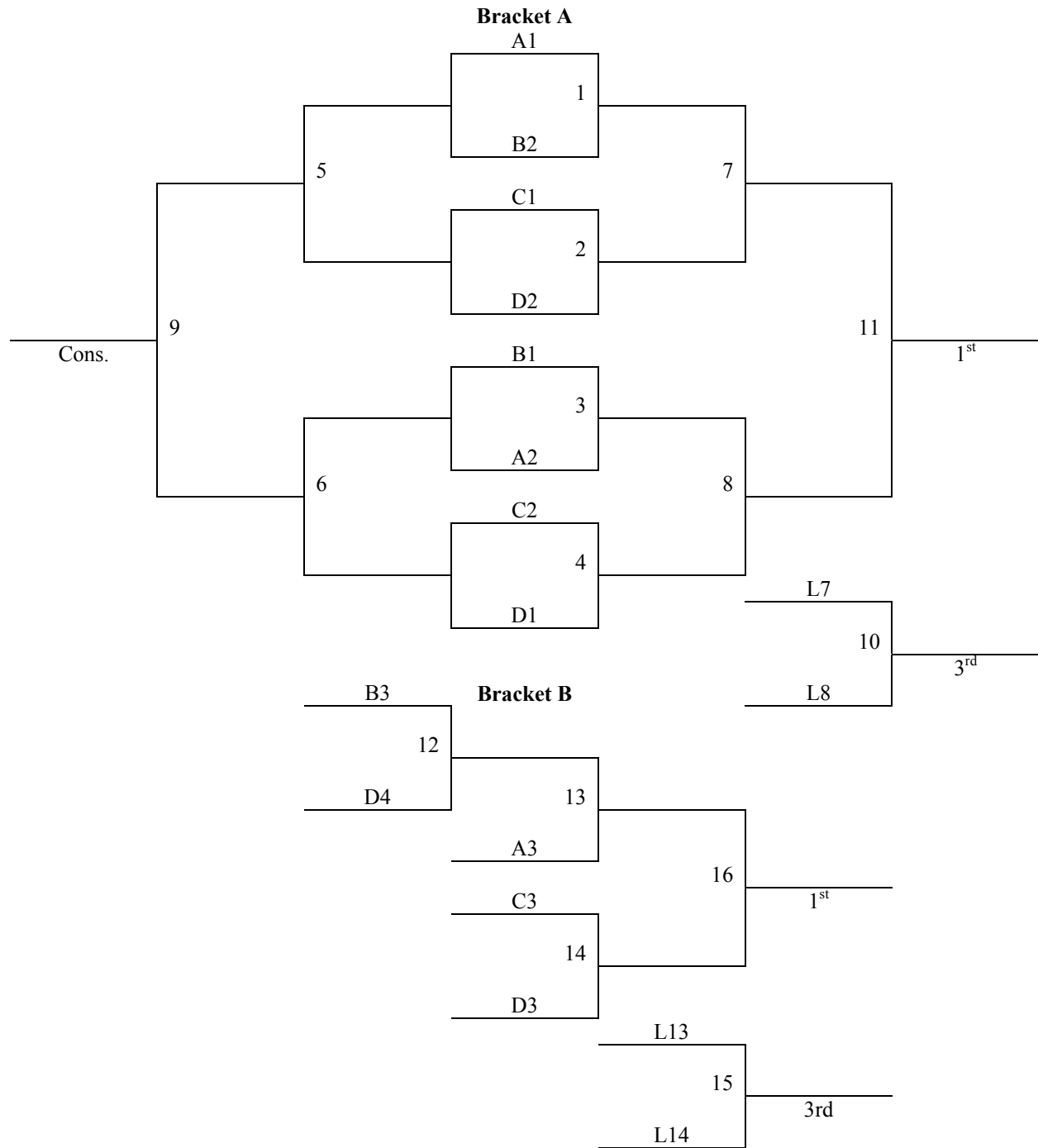

MAYB Winter Finale
March 26-27, 2011
6th Grade Boys

| Pool A | W | L | Pool B | W | L | Pool C | W | L |
|------------------------|----------|----------|---------------------|----------|----------|-----------------------|----------|----------|
| 1. KS Select | | | 4. Team Flight – KS | | | 7. Tulsa Wildcats | | |
| 2. Lawrence Seahawks | | | 5. Renwick Swish | | | 8. Wichita Wolverines | | |
| 3. Scott City Shooters | | | 6. Wamego Spears | | | 9. MO NW Extreme II | | |

| Pool D | W | L | Pool E | W | L |
|-------------------------|----------|----------|---------------------------|----------|----------|
| 10. MO NW Extreme I | | | 13. WCS D Up | | |
| 11. Moundridge Wildcats | | | 14. KS Blues | | |
| 12. Derby Bulls | | | 15. Wichita Defenders Wht | | |
| | | | 16. Spearville Lancers | | |

Top 2 teams in each Pool to Bracket A, Others to Bracket B.
Tie Breaker – 2 way tie = Head to Head, 3 way tie = coin flip

| Saturday | NHS 1 | NHS 2 | Lindley |
|-----------------|--------------|--------------|----------------|
| 8:00 | - | - | - |
| 9:00 | - | - | 11-12 |
| 10:00 | - | - | 13-15 |
| 11:00 | 1-2 | 7-8 | 14-16 |
| 12:00 | - | - | 4-6 |
| 1:00 | - | - | 1-3 |
| 2:00 | 13-14 | 15-16 | 10-12 |
| 3:00 | 7-9 | 5-6 | 2-3 |
| 4:00 | 13-16 | 14-15 | 10-11 |
| 5:00 | - | - | 8-9 |
| 6:00 | - | - | 4-5 |
| 7:00 | G2 | G15 | G16 |
| 8:00 | G1 | G4 | G5 |
| 9:00 | - | - | - |
| Sunday | NHS 1 | NHS 2 | Lindley |
| 8:00 | - | - | - |
| 9:00 | G3 | G6 | - |
| 10:00 | G17 | G18 | G19 |
| 11:00 | - | - | G7 |
| 12:00 | G12 | G13 | - |
| 1:00 | G8 | G9 | - |
| 2:00 | - | - | - |
| 3:00 | G10 | G14 | G20 |
| 4:00 | G11 | - | G21 |
| 5:00 | - | - | - |
| 6:00 | - | - | - |

NHS 1 and 2 = Newton High School - Please Park on the north side of the school and go into the doors on the North side of the building by the back gym.

Lindley = Lindley Hall – Connected to Santa Fe MS – in Newton

Gym Doors will open 30 minutes before the first game. Please do not expect to get into the gym before that time!

MAYB Winter Finale
March 26-27, 2011
6th Grade Boys – Continued

Bracket A

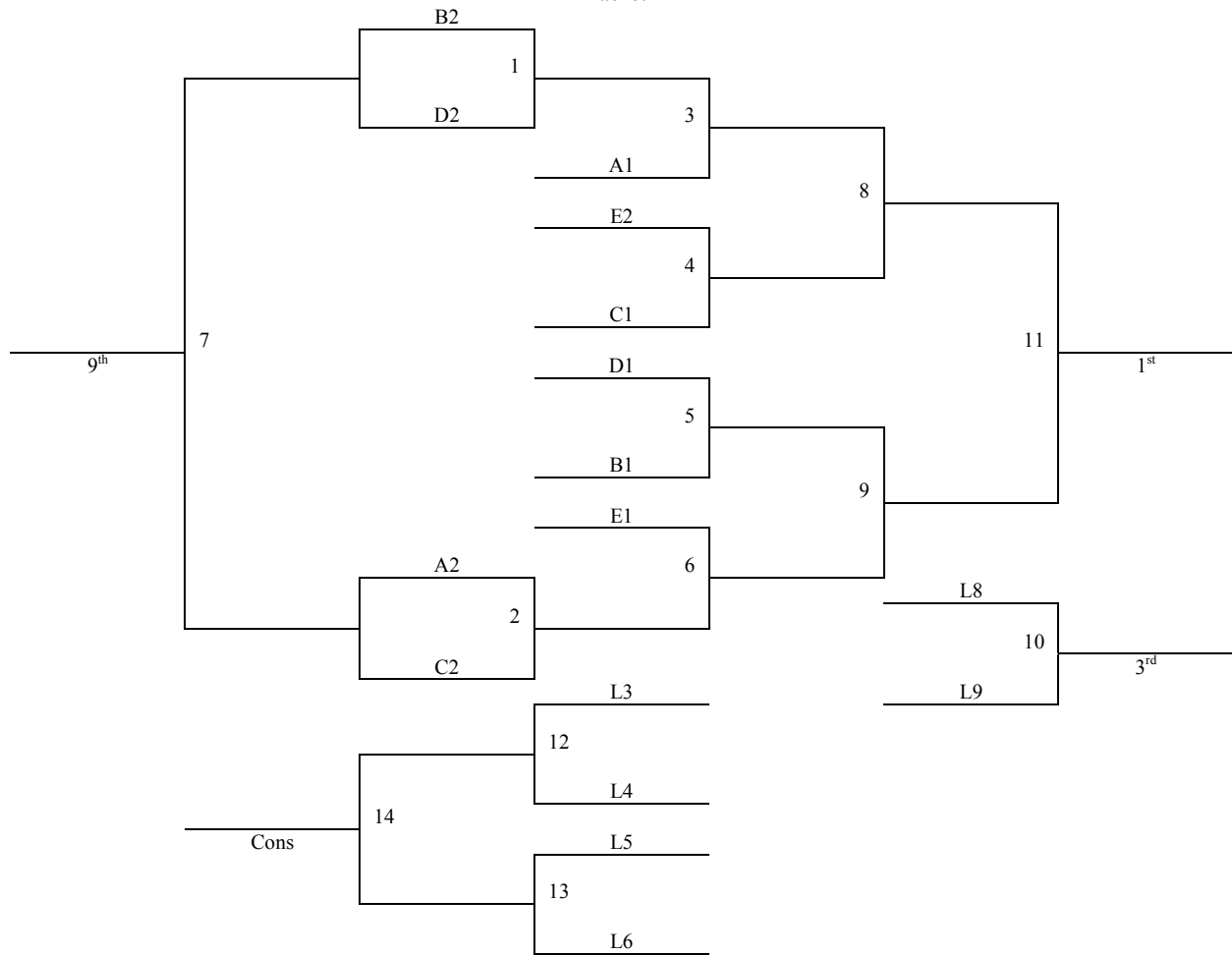

Bracket B

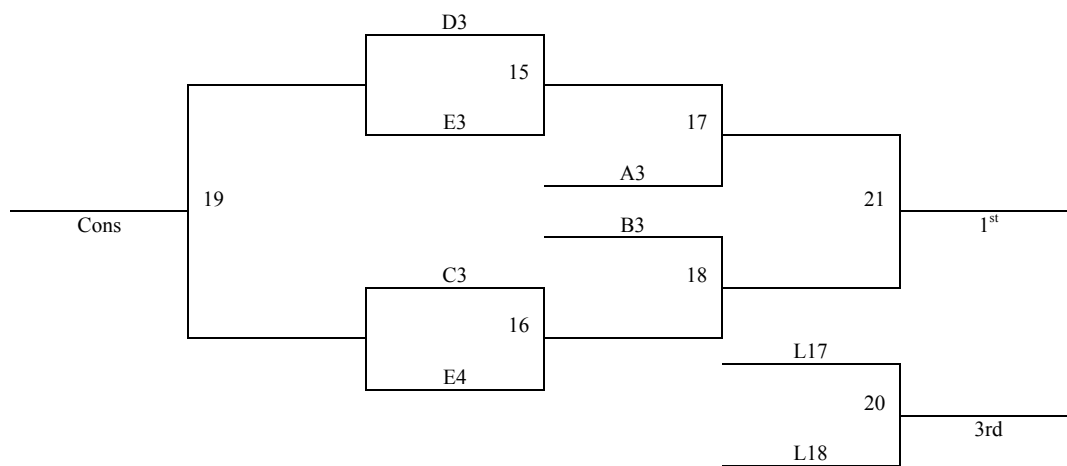

MAYB Winter Finale
March 26-27, 2011
7th Grade Boys

| Pool A | W | L | Pool B | W | L |
|----------------------|----------|----------|-----------------------------|----------|----------|
| 1. Midwest Prospects | | | 4. MO Press | | |
| 2. Wichita Irish | | | 5. West Side Celtics | | |
| 3. Kansas Cagers | | | 6. Next Level Hoops Academy | | |

| Pool C | W | L |
|-------------------------|----------|----------|
| 7. Central Kansas Elite | | |
| 8. Salina Heat | | |
| 9. Anthony Warriors | | |
| 10. KS Flash | | |

Top 2 teams in each Pool to Bracket A, Others to Bracket B.
Tie Breaker – 2 way tie = Head to Head, 3 way tie = coin flip

| Saturday | Newton HS 1 | Newton HS 2 | Lindley |
|-----------------|--------------------|--------------------|----------------|
| 8:00 | - | - | - |
| 9:00 | 1-2 | 5-6 | - |
| 10:00 | 7-8 | 9-10 | - |
| 11:00 | - | - | - |
| 12:00 | 1-3 | 4-5 | - |
| 1:00 | 7-9 | 8-10 | - |
| 2:00 | - | - | - |
| 3:00 | - | - | - |
| 4:00 | - | - | - |
| 5:00 | 2-3 | 4-6 | - |
| 6:00 | 7-10 | 8-9 | - |
| 7:00 | - | - | - |
| 8:00 | - | - | - |
| 9:00 | - | - | - |
| | | | |
| Sunday | Newton HS 1 | Newton HS 2 | Lindley |
| 8:00 | G1 | G2 | G8 |
| 9:00 | - | - | G9 |
| 10:00 | - | - | - |
| 11:00 | G3 | G4 | - |
| 12:00 | - | - | G5 |
| 1:00 | - | - | G10 |
| 2:00 | G7 | G6 | G11 |
| 3:00 | - | - | - |
| 4:00 | - | - | - |
| 5:00 | - | - | - |
| 6:00 | | | |

NHS 1 and 2 = Newton High School – Please Park on the north side of the school and go into the doors on the North side of the building by the back gym.

Lindley = Lindley Hall – Connected to Santa Fe MS – in Newton

Women's Sized ball (28.5) will be used in the 7th grade boys division!

Gym Doors will open 30 minutes before the first game. Please do not expect to get into the gym before that time!

MAYB Winter Finale
March 26-27, 2011
7th Grade Boys - Continued

Bracket A

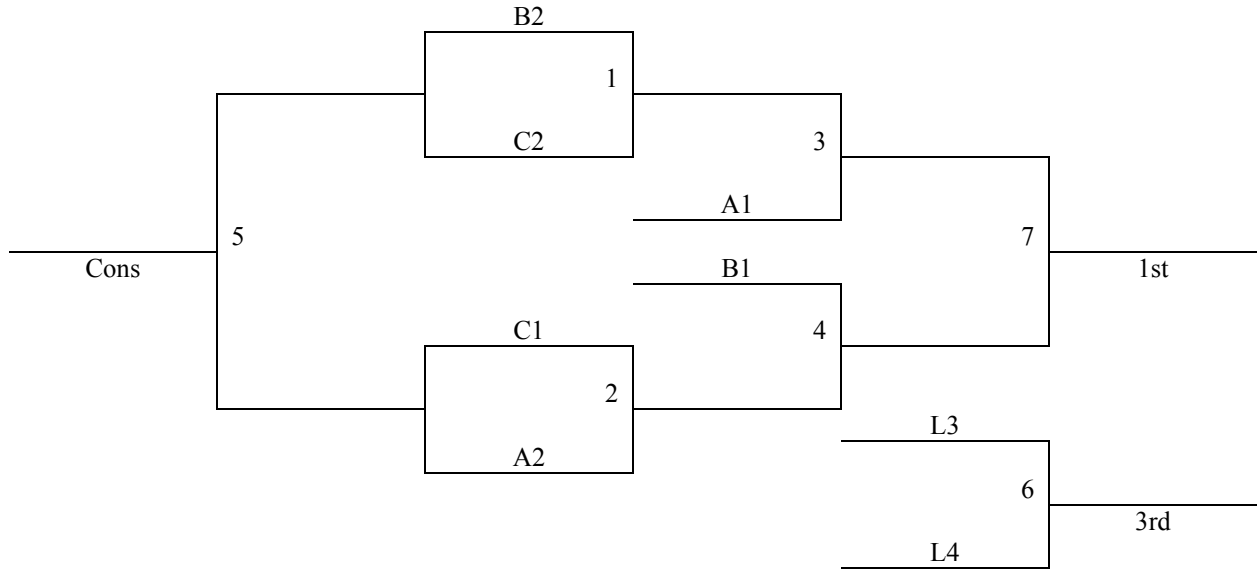

Bracket B

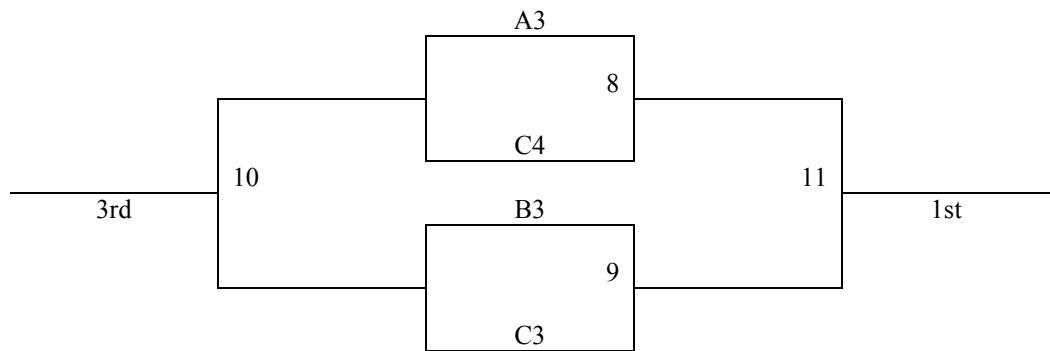

MAYB Winter Finale
March 26-27, 2011
8th Grade Boys

| Pool A | W | L | Pool B | W | L | Pool C | W | L |
|---------------------------|----------|----------|-------------------|----------|----------|--------------------|----------|----------|
| 1. Next Level Hoops Acd. | | | 4. Kansas Thunder | | | 7. Kansas Crunch | | |
| 2. KS Cagers Red | | | 5. Mid Kansas | | | 8. Lansing Lions | | |
| 3. Wichita Running Rebels | | | 6. Bowman Oilers | | | 9. Barton Shockers | | |

| Pool D | W | L | Pool E | W | L |
|-------------------------|----------|----------|----------------------|----------|----------|
| 10. Crusaders | | | 14. CDU – KS | | |
| 11. KS Warriors | | | 15. Southwest Kansas | | |
| 12. KS Cagers Blue | | | 16. Liberal Thunder | | |
| 13. Spring Hill Broncos | | | 17. Mid KS Red Storm | | |

Top 2 teams in pools A-C to Bracket A, other to Bracket B.

Top team in pools D-E to Bracket B, others to Bracket C.

Tie Breaker – 2 way tie = Head to Head, 3 way tie – coin flip

| Saturday | Hesston HS 1 | Hesston HS 2 |
|-----------------|---------------------|---------------------|
| 8:00 | - | - |
| 9:00 | 10-11 | 14-17 |
| 10:00 | 7-9 | 1-3 |
| 11:00 | 5-6 | 15-16 |
| 12:00 | 7-8 | 11-12 |
| 1:00 | 4-5 | 1-2 |
| 2:00 | 14-15 | 16-17 |
| 3:00 | 10-13 | 8-9 |
| 4:00 | 2-3 | 4-6 |
| 5:00 | 11-13 | 10-12 |
| 6:00 | 14-16 | 15-17 |
| 7:00 | 12-13 | G1 |
| 8:00 | G2 | - |
| 9:00 | - | - |
| | | |
| Sunday | Hesston HS 1 | Hesston HS 2 |
| 8:00 | G17 | G18 |
| 9:00 | G8 | G9 |
| 10:00 | G10 | G5 |
| 11:00 | G20 | G19 |
| 12:00 | G12 | G13 |
| 1:00 | G4 | G3 |
| 2:00 | G11 | G15 |
| 3:00 | G6 | G16 |
| 4:00 | G7 | G14 |
| 5:00 | - | - |
| 6:00 | - | - |

Hesston HS 1 and 2 = Hesston High School Courts 1 and 2 – in Hesston Men's Sized ball (29.5) will be used in the 8th Grade Boys division

Gym Doors will open 30 minutes before the first game. Please do not expect to get into the gym before that time!

MAYB Winter Finale
March 26-27, 2011
8th Grade Boys - Continued

Bracket A

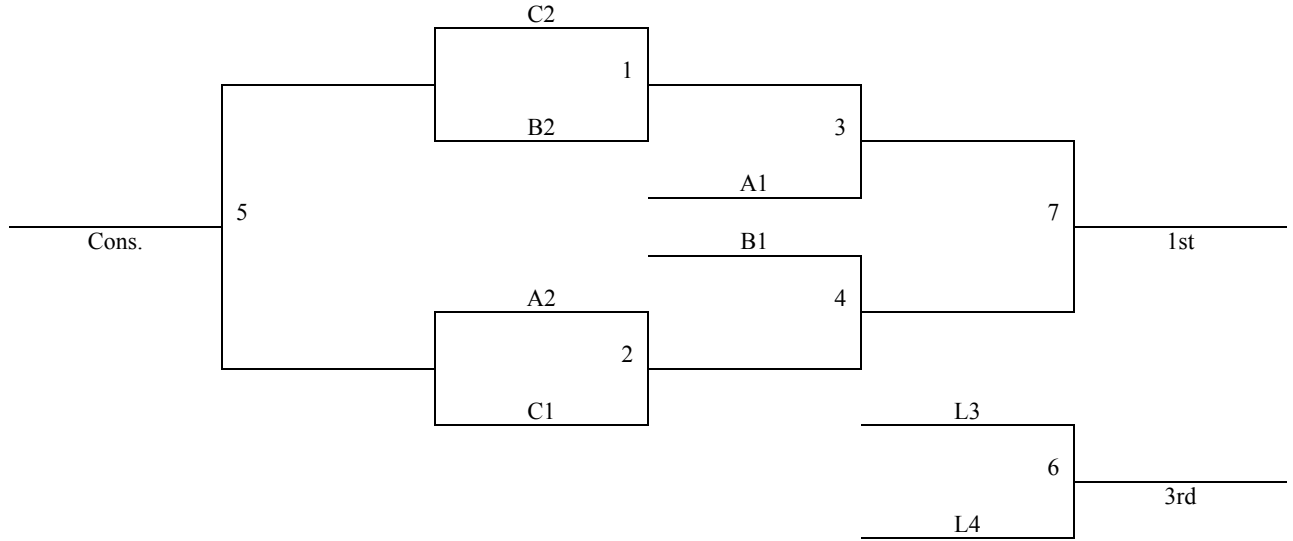

Bracket B

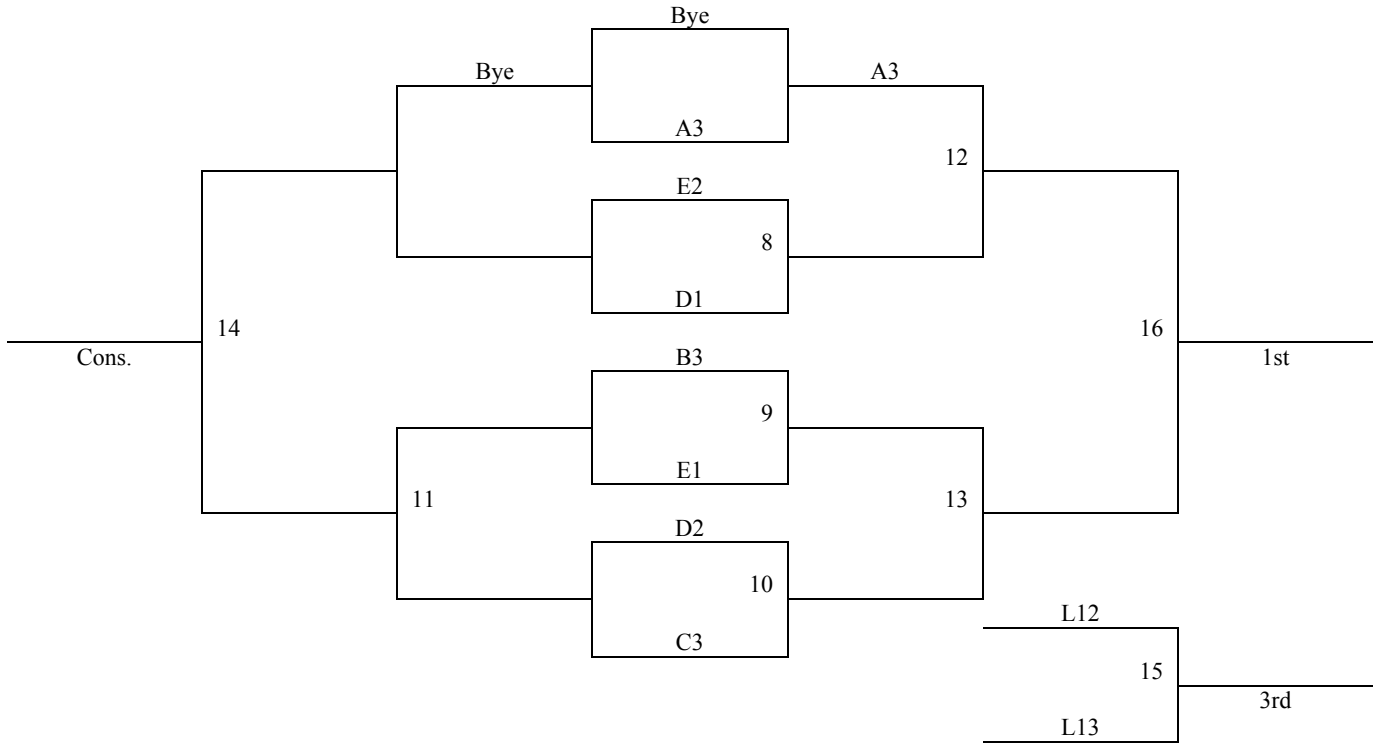

MAYB Winter Finale
March 26-27, 2011
8th Grade Boys - Continued

Bracket C

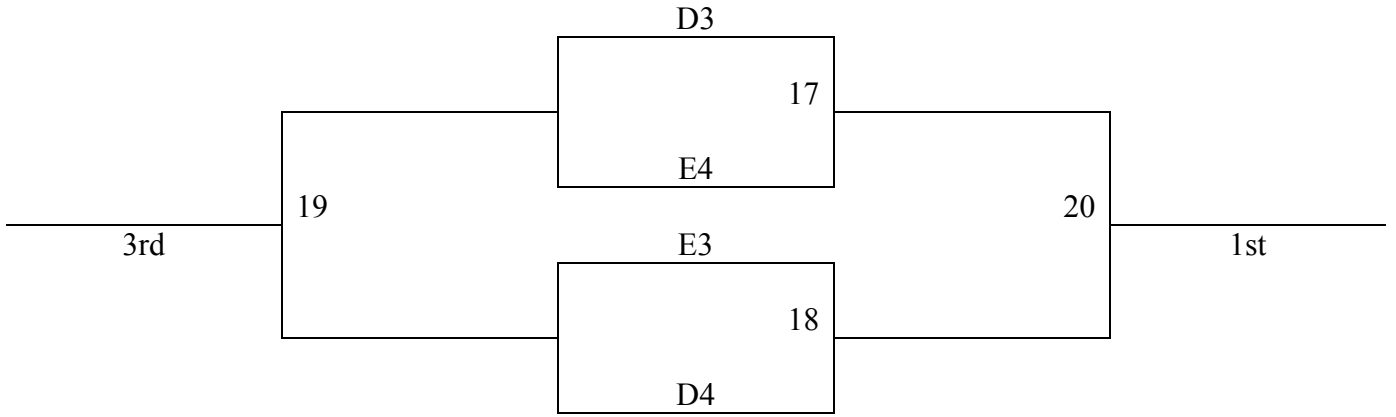

MAYB Winter Finale
March 26-27, 2011
9/10th Grade Boys

| Pool A | W | L | Pool B | W | L |
|-------------------------|----------|----------|---------------------------------|----------|----------|
| 1. KC Pumas | | | 4. MO Flight | | |
| 2. Wichita Mustangs Red | | | 5. Next Level Hoops Academy Org | | |
| 3. Central KS Tigers | | | 6. Mid KS Renegades | | |

All teams to Bracket.
Tie Breaker – 2 way tie = Head to Head, 3 way tie = coin flip

| Saturday | MHS |
|-----------------|------------|
| 8:00 | - |
| 9:00 | 4-6 |
| 10:00 | - |
| 11:00 | - |
| 12:00 | 1-2 |
| 1:00 | 5-6 |
| 2:00 | - |
| 3:00 | - |
| 4:00 | 1-3 |
| 5:00 | 4-5 |
| 6:00 | 2-3 |
| 7:20 | G1 |
| 8:20 | G2 |
| 9:00 | - |
| | |
| Sunday | MHS |
| 8:00 | - |
| 9:00 | - |
| 10:00 | - |
| 11:00 | G3 |
| 12:00 | G4 |
| 1:00 | G5 |
| 2:00 | G6 |
| 3:00 | G7 |
| 4:00 | - |
| 5:00 | - |
| 6:00 | - |

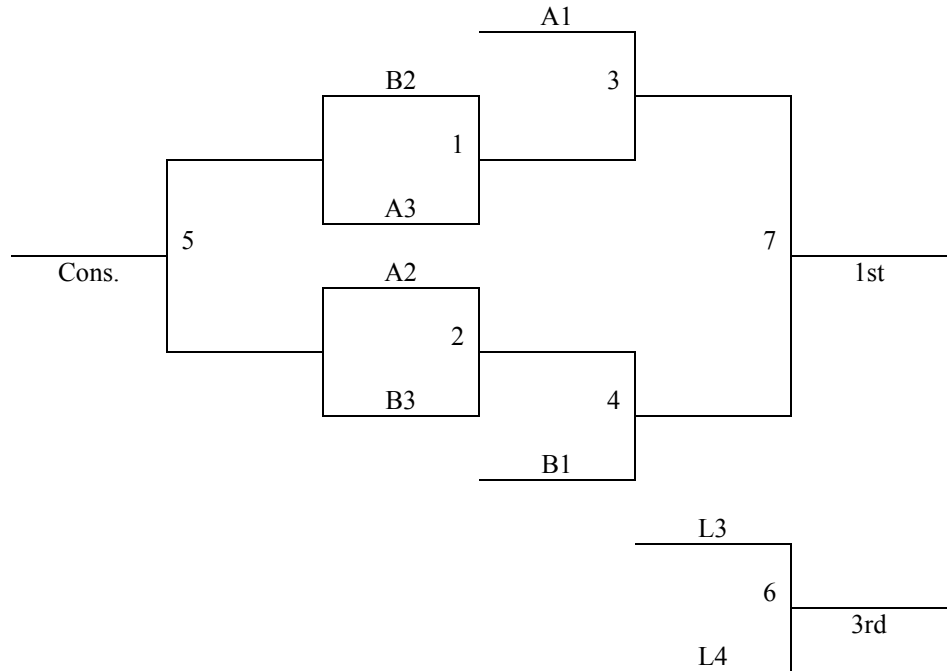

MHS = Moundridge High School – in Moundridge

Gym Doors will open 30 minutes before the first game. Please do not expect to get into the gym before that time!

MAYB Winter Finale
March 26-27, 2011
11/12th Grade Boys

| Pool A | W | L | Pool B | W | L |
|-------------------------------|----------|----------|--------------------------|----------|----------|
| 1. KS Players | | | 4. Kansas Select | | |
| 2. Topeka Mustangs | | | 5. Wichita Mustangs Blk | | |
| 3. Next Level Hoops Acd - Blk | | | 6. Lords of the Rim – MO | | |
| | | | 7. Central KS Twisterz | | |

All teams to Bracket.
Tie Breaker – 2 way tie = Head to Head, 3 way tie = coin flip

| Saturday | MHS | Bethel |
|-----------------|------------|---------------|
| 8:00 | - | - |
| 9:00 | - | - |
| 10:00 | 4-5 | - |
| 11:00 | 6-7 | 1-3 |
| 12:00 | - | - |
| 1:00 | - | - |
| 2:00 | 4-7 | 2-3 |
| 3:00 | 5-6 | - |
| 4:00 | - | - |
| 5:00 | - | 5-7 |
| 6:00 | - | 4-6 |
| 7:00 | - | - |
| 8:00 | - | 1-2 |
| 9:00 | - | - |
| | | |
| Sunday | MHS | Bethel |
| 8:00 | G1 | - |
| 9:00 | G2 | - |
| 10:00 | G3 | - |
| 11:00 | - | - |
| 12:00 | - | G4 |
| 1:00 | - | G5 |
| 2:00 | - | - |
| 3:00 | - | G6 |
| 4:00 | - | - |
| 5:00 | - | - |
| 6:00 | - | - |

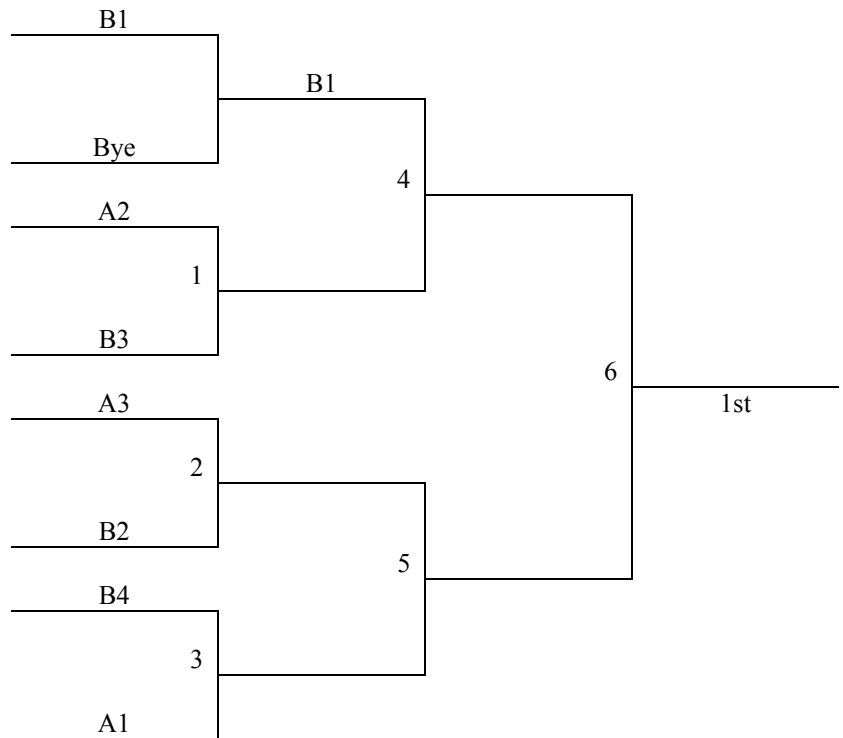

MHS = Moundridge High School – in Moundridge
Bethel = Bethel College – in North Newton

Gym Doors will open 30 minutes before the first game. Please do not expect to get into the gym before that time!



MAYB Winter Finale
March 26-27, 2011
4th Grade Girls

| Pool A | W | L |
|------------------------|----------|----------|
| 1. Wichita Lady Magic | | |
| 2. Newton Jr. Railers | | |
| 3. Pratt Green Thunder | | |
| 4. KS Dream Team | | |
| 5. Ulysses Allstars | | |

Round Robin Tournament – 1st and 2nd Seeds will play for Championship
 Tie Breaker – 2 way tie = Head to Head, 3 way tie = +/- 15 pts

| Saturday | Hesston MS | Chish 1 | Chish 2 |
|-----------------|-------------------|----------------|----------------|
| 8:00 | - | - | - |
| 9:00 | 1-2 | - | - |
| 10:00 | 3-4 | - | - |
| 11:00 | - | - | - |
| 12:00 | - | - | - |
| 1:00 | 1-3 | - | - |
| 2:00 | 2-5 | - | - |
| 3:00 | - | - | - |
| 4:00 | - | - | - |
| 5:00 | 4-5 | - | - |
| 6:00 | - | - | - |
| 7:00 | - | - | - |
| 8:00 | - | - | - |
| 9:00 | - | - | - |
| | | | |
| Sunday | Hesston MS | Chish 1 | Chish 2 |
| 8:00 | - | - | - |
| 9:00 | - | 1-5 | 2-4 |
| 10:00 | - | - | - |
| 11:00 | - | - | - |
| 12:00 | - | - | 2-3 |
| 1:00 | - | - | - |
| 2:00 | - | 1-4 | 3-5 |
| 3:00 | - | - | - |
| 4:00 | - | - | G1 |
| 5:00 | - | - | - |
| 6:00 | - | - | - |

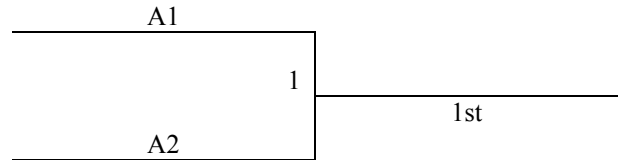

Hesston MS = Hesston Middle School – Hesston, KS
 Chish 1 and 2 = Chisholm Middle School – Newton, KS

Gym Doors will open 30 minutes before the first game. Please do not expect to get into the gym before that time!

MAYB Winter Finale
March 26-27, 2011
5th/6th Grade Girls – Division II

| Pool A | W | L |
|------------------------------|----------|----------|
| 1. Emporia Thunderbolts | | |
| 2. Sedgwick Rebels | | |
| 3. Circle Swishers | | |
| 4. Colwich/Andale | | |
| 5. Newton Jr. Railers -5/6th | | |

Round Robin Tournament – 1st and 2nd Seeds will play for Championship

Tie Breaker – 2 way tie = Head to Head, 3 way tie = +/- 15 pts

*Revised 3-23

| Saturday | Ha MS 1 | Ha MS 2 |
|-----------------|----------------|----------------|
| 8:00 | - | - |
| 9:00 | 3-5 | 2-4 |
| 10:00 | - | - |
| 11:00 | 2-3 | 1-5 |
| 12:00 | - | - |
| 1:00 | - | - |
| 2:00 | 1-4 | 2-5 |
| 3:00 | - | - |
| 4:00 | - | - |
| 5:00 | - | - |
| 6:00 | - | - |
| 7:00 | - | - |
| 8:00 | - | - |
| 9:00 | - | - |
| | | |
| Sunday | Ha MS 1 | Ha MS 2 |
| 8:00 | - | - |
| 9:00 | - | - |
| 10:00 | 1-2 | 3-4 |
| 11:00 | - | - |
| 12:00 | - | - |
| 1:00 | - | - |
| 2:00 | 1-3 | 4-5 |
| 3:00 | - | - |
| 4:00 | G1 | - |
| 5:00 | - | - |
| 6:00 | - | - |

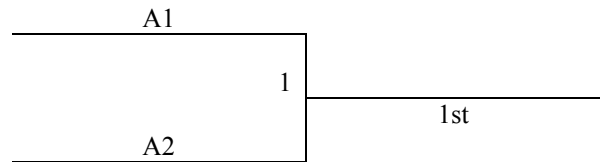

Ha MS 1 and 2 = Halstead Middle School Court 1 and 2

Gym Doors will open 30 minutes before the first game. Please do not expect to get into the gym before that time!

MAYB Winter Finale
March 26-27, 2011
5th Grade Girls

| Pool A | W | L | Pool B | W | L |
|-------------------------|----------|----------|-----------------------|----------|----------|
| 1. Wichita Saints | | | 4. Wichita Lady Magic | | |
| 2. Wichita Xpress | | | 5. Kansas Hoops | | |
| 3. Ark City DARE Devils | | | 6. BGC Allstars | | |

All teams to Bracket A
Tie Breaker – 2 way – Head to Head, 3 way – Coin Flip

| Saturday | Ha MS 1 | Ha MS 2 |
|-----------------|----------------|----------------|
| 8:00 | - | - |
| 9:00 | - | - |
| 10:00 | 2-3 | 4-5 |
| 11:00 | - | - |
| 12:00 | - | - |
| 1:00 | 1-2 | 5-6 |
| 2:00 | - | - |
| 3:00 | - | - |
| 4:00 | - | - |
| 5:00 | 4-6 | 1-3 |
| 6:00 | - | - |
| 7:00 | G1 | G2 |
| 8:00 | - | - |
| 9:00 | - | - |
| | | |
| Sunday | Ha MS 1 | Ha MS 2 |
| 8:00 | - | - |
| 9:00 | G3 | G4 |
| 10:00 | - | - |
| 11:00 | - | - |
| 12:00 | - | - |
| 1:00 | G5 | - |
| 2:00 | - | - |
| 3:00 | G7 | G6 |
| 4:00 | - | - |
| 5:00 | - | - |
| 6:00 | - | - |

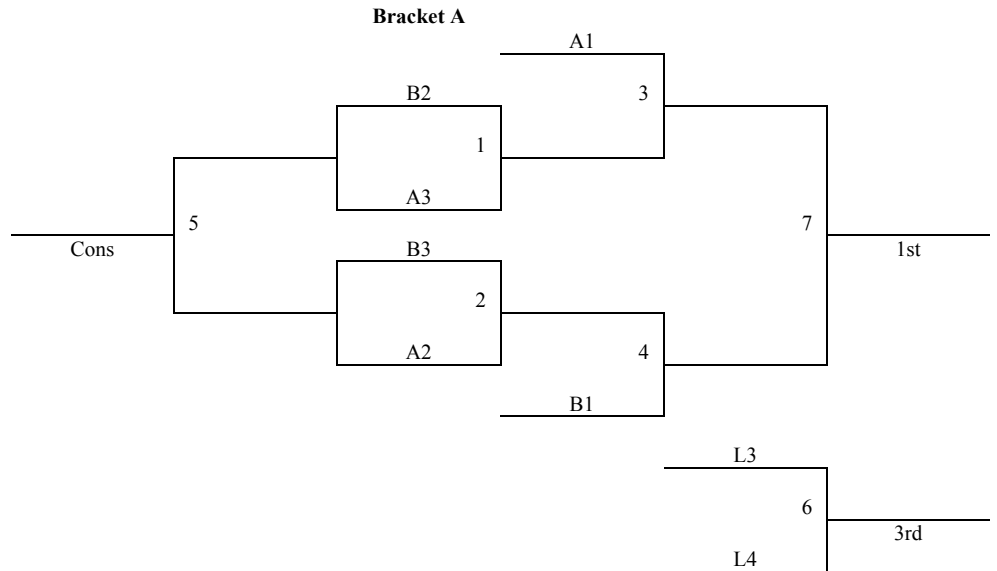

Ha MS 1 and 2 = Halstead Middle School Court 1 and 2

Gym Doors will open 30 minutes before the first game. Please do not expect to get into the gym before that time!

MAYB Winter Finale
March 26-27, 2011
6th Grade Girls

| Pool A | W | L | Pool B | W | L |
|------------------------|----------|----------|---------------------|----------|----------|
| 1. Manhattan Lady Cats | | | 4. MO Phenom Comets | | |
| 2. Jr. Runners | | | 5. WSC All Stars | | |
| 3. KS Dream Team | | | 6. JC Lady Jays | | |

| Pool C | W | L | Pool D | W | L |
|---------------------|----------|----------|----------------------|----------|----------|
| 7. Wichita Dazzle | | | 10. KS Shox | | |
| 8. KS Eclipse/Sparq | | | 11. Wichita Stars | | |
| 9. C.S. Cardinals | | | 12. Omaha Legacy Red | | |

Top two teams in each pool to Bracket A. Others to Bracket B
 Tie Breaker – 2 way time = Head to Head, 3 way tie = coin flip

| Saturday | Ha MS 1 | Ha MS 2 | Ha HS 1 | Ha HS 2 |
|-----------------|----------------|----------------|----------------|----------------|
| 8:00 | - | - | - | - |
| 9:00 | - | - | - | - |
| 10:00 | - | - | - | - |
| 11:00 | - | - | - | - |
| 12:00 | 5-6 | 2-3 | - | - |
| 1:00 | - | - | 10-12 | 7-9 |
| 2:00 | - | - | - | - |
| 3:00 | 1-2 | 4-5 | - | - |
| 4:00 | 7-8 | 11-12 | - | - |
| 5:00 | - | - | - | - |
| 6:00 | 8-9 | 1-3 | 10-11 | 4-6 |
| 7:00 | - | - | - | - |
| 8:00 | G1 | G2 | - | - |
| 9:00 | G3 | G4 | - | - |
| | | | | |
| Sunday | Ha MS 1 | Ha MS 2 | Ha HS 1 | Ha HS 2 |
| 8:00 | G12 | G13 | - | - |
| 9:00 | - | - | - | - |
| 10:00 | - | - | - | - |
| 11:00 | G5 | G6 | G7 | G8 |
| 12:00 | G15 | G14 | - | - |
| 1:00 | - | G9 | - | - |
| 2:00 | -- | - | G11 | G10 |
| 3:00 | - | - | - | - |
| 4:00 | - | - | - | - |
| 5:00 | - | - | - | - |
| 6:00 | - | - | - | - |

Ha MS 1 and 2 = Halstead Middle School Court 1 and 2

Ha HS 1 and 2 = Halstead High School Court 1 and 2

Gym Doors will open 30 minutes before the first game. Please do not expect to get into the gym before that time!

MAYB Winter Finale
March 26-27, 2011
6th Grade Girls – Cont.

Bracket A

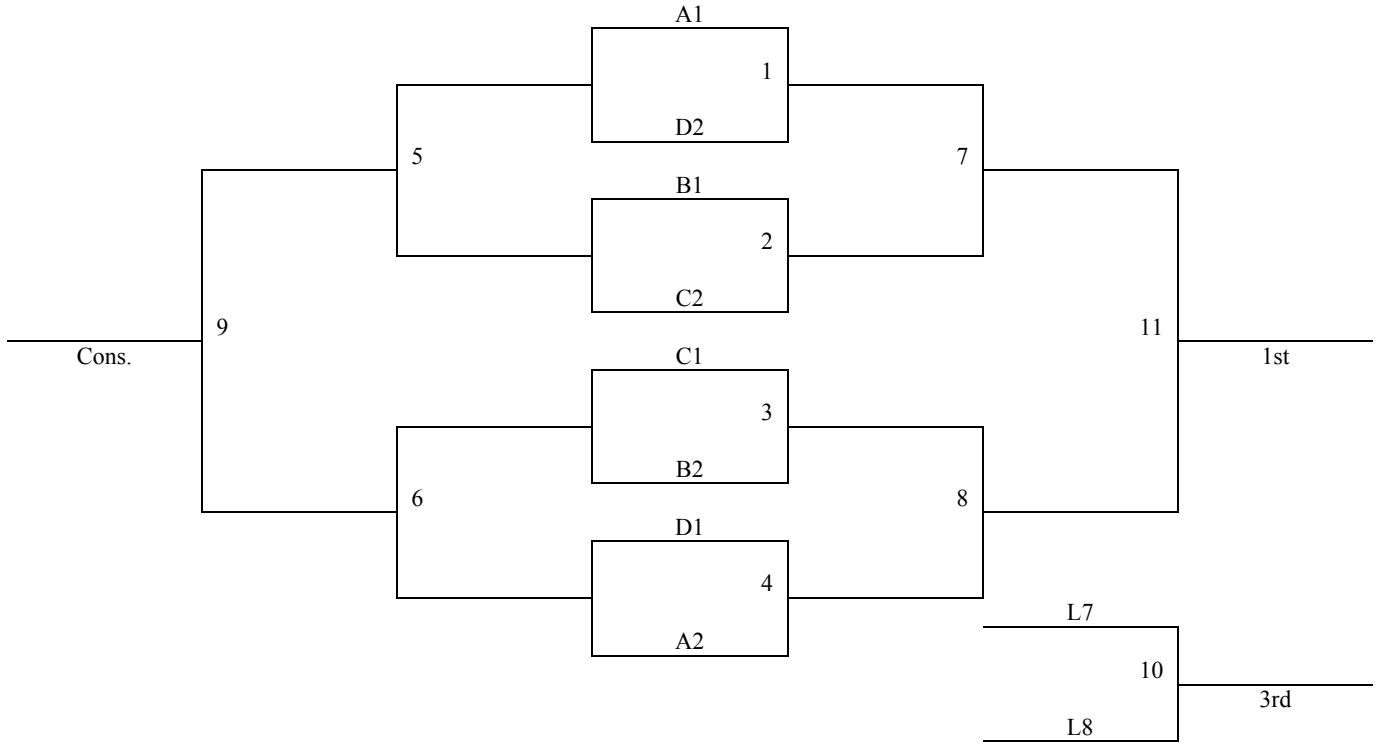

Bracket B

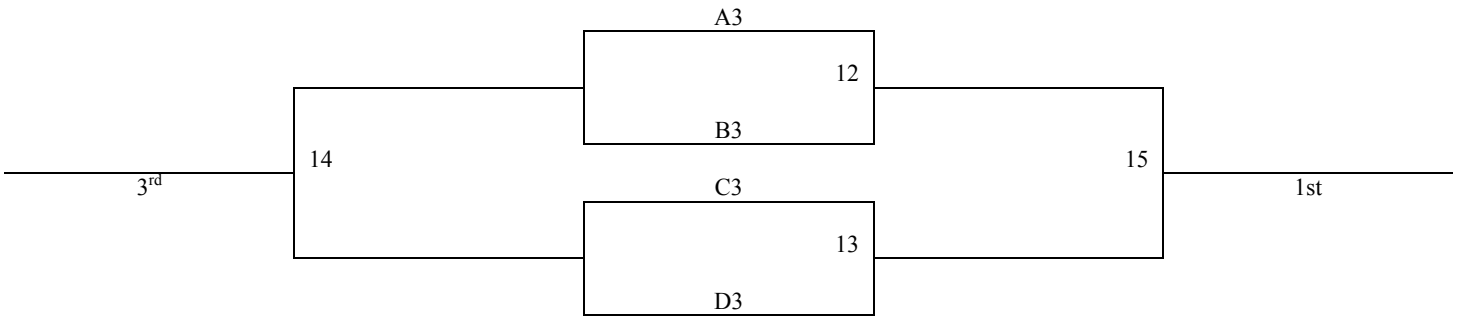

MAYB Winter Finale
March 26-27, 2011
7th Grade Girls

| Pool A | W | L | Pool B | W | L |
|-----------------------------|----------|----------|------------------|----------|----------|
| 1. Kansas Legends | | | 4. Kansas Angels | | |
| 2. Dream Team – Bohnenblust | | | 5. Hot Shots –KS | | |
| 3. Wichita Dynamite | | | 6. KS Dream Team | | |

All teams to Bracket.
Tie Breaker – 2 way tie = Head to Head, 3 way tie = coin flip

| Saturday | Ha HS 1 | Ha HS 2 |
|-----------------|----------------|----------------|
| 8:00 | - | - |
| 9:00 | 1-3 | 4-5 |
| 10:00 | - | - |
| 11:00 | - | - |
| 12:00 | 4-6 | 1-2 |
| 1:00 | - | - |
| 2:00 | - | - |
| 3:00 | - | - |
| 4:00 | 2-3 | 5-6 |
| 5:00 | - | - |
| 6:00 | - | - |
| 7:00 | - | - |
| 8:00 | G1 | G2 |
| 9:00 | - | - |
| | | |
| Sunday | Ha HS 1 | Ha HS 2 |
| 8:00 | - | - |
| 9:00 | G3 | G4 |
| 10:00 | - | - |
| 11:00 | - | - |
| 12:00 | - | - |
| 1:00 | - | G5 |
| 2:00 | - | - |
| 3:00 | G7 | G6 |
| 4:00 | - | - |
| 5:00 | - | - |
| 6:00 | - | - |

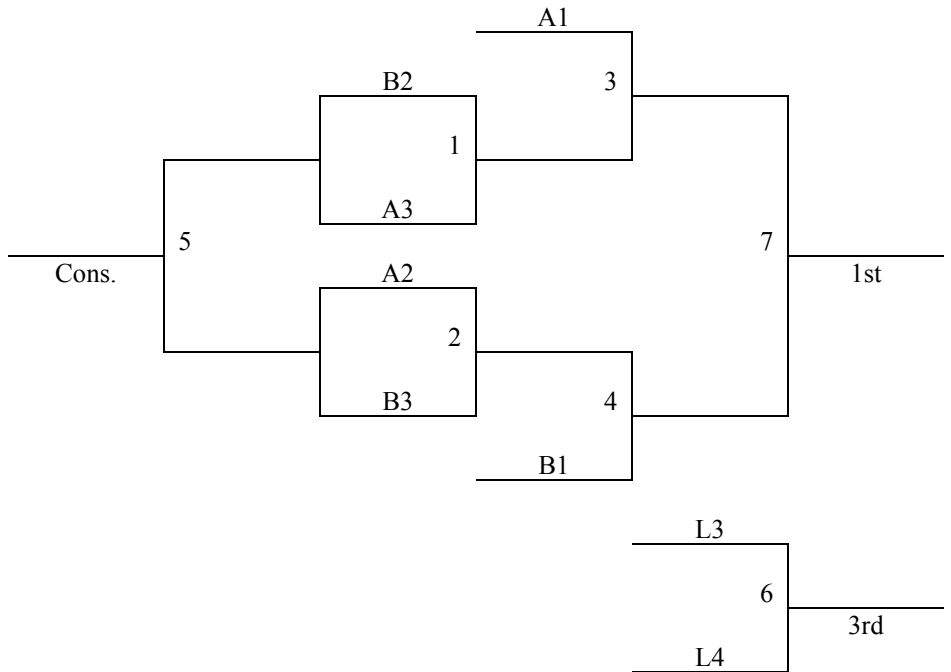

Ha HS 1 and 2 = Halstead High School Court 1 and 2

Gym Doors will open 30 minutes before the first game. Please do not expect to get into the gym before that time!

MAYB Winter Finale
March 26-27, 2011
8th Grade Girls

| Pool A | W | L | Pool B | W | L |
|--------------------|----------|----------|-----------------------|----------|----------|
| 1. Show Me Chaos | | | 4. Fatima Comets – MO | | |
| 2. SW Dragons – KS | | | 5. Hoopsters – KS | | |
| 3. Tulsa Titans | | | 6. Omaha Legacy Black | | |

| Pool C | W | L |
|------------------------|----------|----------|
| 7. Lincoln Lasers Gold | | |
| 8. KS Dream Team | | |
| 9. Flint Hills Starz | | |
| 10. Lady Prospects 13U | | |

Top 2 teams from each pool to Bracket A, others to Bracket B
Tie Breaker – 2 way – Head to Head, 3 way – Coin Flip

| Saturday | Ha HS 1 | Ha HS 2 |
|-----------------|----------------|----------------|
| 8:00 | - | - |
| 9:00 | - | - |
| 10:00 | 8-9 | 5-6 |
| 11:00 | 7-10 | 1-2 |
| 12:00 | - | - |
| 1:00 | - | - |
| 2:00 | 7-9 | 8-10 |
| 3:00 | 2-3 | 4-5 |
| 4:00 | - | - |
| 5:00 | 7-8 | 9-10 |
| 6:00 | - | - |
| 7:00 | 1-3 | 4-6 |
| 8:00 | - | - |
| 9:00 | G1 | G2 |
| | | |
| Sunday | Ha HS 1 | Ha HS 2 |
| 8:00 | G8 | G9 |
| 9:00 | - | - |
| 10:00 | G3 | G4 |
| 11:00 | - | - |
| 12:00 | G10 | G11 |
| 1:00 | G5 | - |
| 2:00 | - | - |
| 3:00 | - | - |
| 4:00 | G7 | G6 |
| 5:00 | - | - |
| 6:00 | - | - |

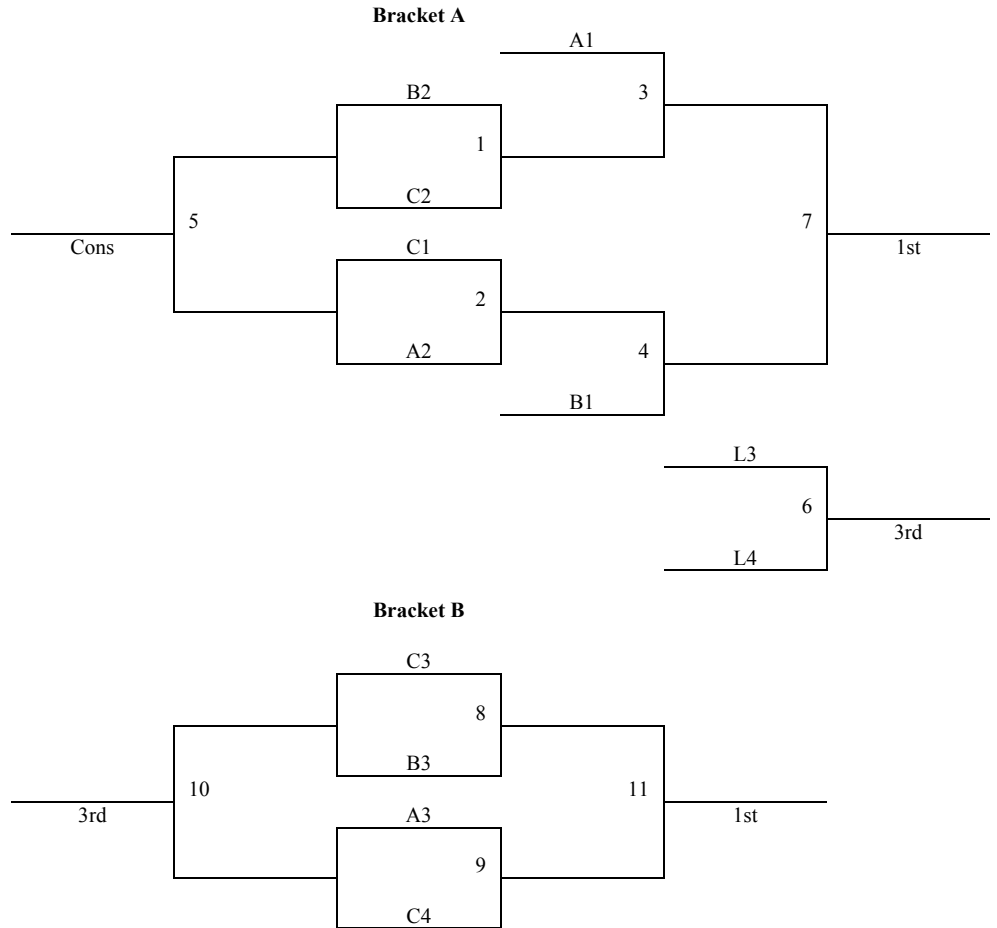

Ha HS 1 and 2 = Halstead High School Court 1 and 2

Gym Doors will open 30 minutes before the first game. Please do not expect to get into the gym before that time!

**MAYB Winter Finale
March 26-27, 2011
High School Girls**

| Pool A | W | L |
|--------------------------------|----------|----------|
| 1. Wichita Panthers | | |
| 2. KS Eclipse/Sparq – Bachrodt | | |
| 3. Pike Trail | | |
| 4. KS Eclipse/Sparq – Finch | | |
| 5. KS Dream Team | | |

Round Robin Tournament – 1st and 2nd Seeds will play for Championship
Tie Breaker – 2 way tie = Head to Head, 3 way tie = +/- 15 pts

| Saturday | Bethel |
|-----------------|---------------|
| 8:00 | - |
| 9:00 | - |
| 10:00 | - |
| 11:00 | - |
| 12:00 | 1-3 |
| 1:00 | 2-5 |
| 2:00 | - |
| 3:00 | 1-2 |
| 4:00 | 3-4 |
| 5:00 | - |
| 6:00 | - |
| 7:00 | 4-5 |
| 8:00 | - |
| 9:00 | - |
| | |
| Sunday | Bethel |
| 8:00 | 1-4 |
| 9:00 | 3-5 |
| 10:00 | 2-4 |
| 11:00 | 1-5 |
| 12:00 | - |
| 1:00 | - |
| 2:00 | 2-3 |
| 3:00 | - |
| 4:00 | G1 |
| 5:00 | - |
| 6:00 | - |

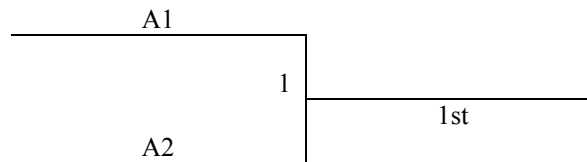

Bethel = Bethel College – North Newton, KS

Gym Doors will open 30 minutes before the first game. Please do not expect to get into the gym before that time!